

# OWNER'S MANUAL

## How to operate your EcoWater Systems Water Conditioner/Refiner

**ECOWATER**  
S Y S T E M S<sup>®</sup>



Your Water. Perfected.

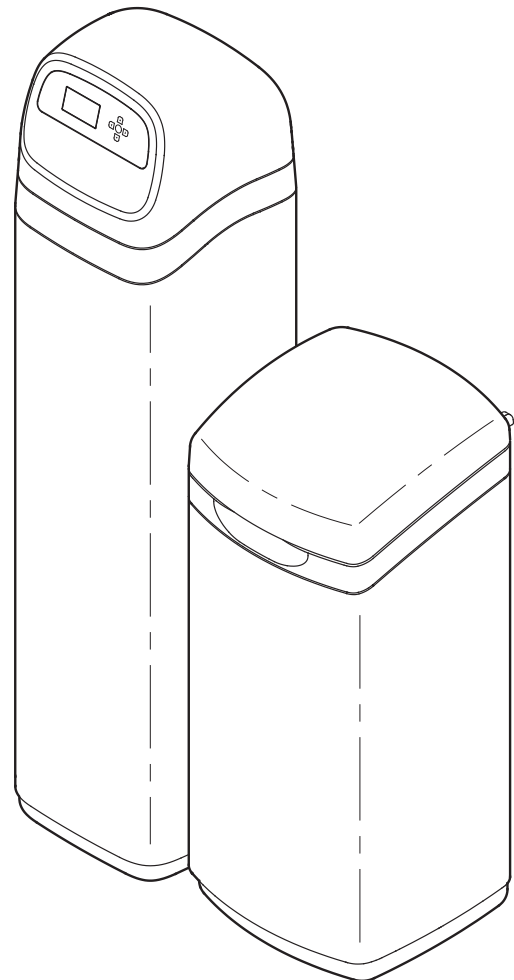
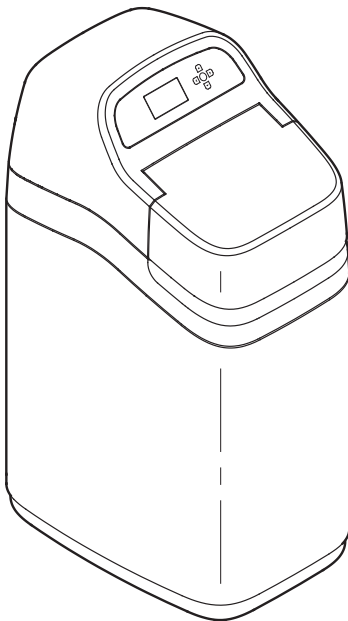
### **SERIES 3700 & 3702**

HydroLink<sup>®</sup> & HydroLink Plus<sup>®</sup>

Conditioners (ECR)

Refiners (ERR)

Chloramine & Chlorine Conditioner (ERRC)\*



Systems tested and certified by NSF International against NSF/ANSI Standard 44 for hardness reduction and efficiency and the reduction of barium and radium 226/228, and certified to NSF/ANSI Standard 372.

ERR3700R20, ERR3702R30 & ERR3702R50 are tested and certified by NSF International against NSF/ANSI Standard 42 for chlorine taste and odor.

Systems tested and certified by the Water Quality Association against CSA B483.1.



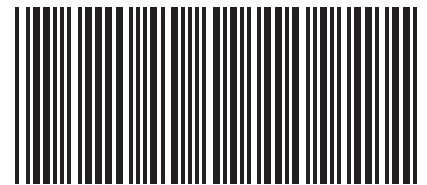
C US

\* Model ERRC3702R50 has not been tested or certified by NSF International or the Water Quality Association.



Designed, Engineered &  
Assembled in the U.S.A.

EcoWater Systems LLC  
P.O. Box 64420, St. Paul, MN 55164-0420  
www.ecowater.com



7354727 (Rev. D 12/22/16)

**TABLE OF CONTENTS**

	<u>Page</u>
Warranty .....	3
Guarantee .....	4
Specifications & Performance Claims .....	5-6
Dimensions .....	7-8
Planning Installation .....	9
Unpacking .....	10
Installation .....	10-12
Wi-Fi Systems: Setup, Connect & Registration .	13-16
Non-Wi-Fi Systems: Setup & Remote .....	17-27
Conditioner/Refiner Operation .....	28-41
Service Information .....	42-47
Adding Salt .....	42
Troubleshooting Guide .....	45
Schematic .....	48
Repair Parts .....	50-55

**SAFETY GUIDES**

Follow the installation instructions carefully. Failure to install the EcoWater Systems conditioner/refiner properly **voids the warranty**.

Before you begin installation, read this entire manual. Then, obtain all the materials and tools you will need to make the installation.

**Check local plumbing and electrical codes.** The installation must conform to them.

**Use only lead-free solder and flux** for all sweat-solder connections, as required by state and federal codes.

Use care when handling the EcoWater Systems conditioner/refiner. Do not turn upside down, drop, or set on sharp protrusions.

Do not locate the EcoWater Systems conditioner/refiner where freezing temperatures occur. Do not attempt to treat water over 120°F. **Freezing, or hot water damage voids the warranty.**

Avoid installing in direct sunlight. Excessive sun heat may cause distortion or other damage to non-metallic parts.

The EcoWater Systems conditioner/refiner requires a minimum water flow of 3 gallons per minute at the inlet. **Maximum allowable inlet water pressure is 125 psi.** If daytime pressure is over 80 psi, nighttime pressure may exceed the maximum. Use a pressure reducing valve if necessary (Adding a pressure reducing valve may reduce the flow).

The EcoWater Systems conditioner/refiner works on **24V DC** electrical power, supplied by a direct plug-in power supply (included). Be sure to use the included power supply, and plug it into a nominal **120V, 60 Hz** household outlet that is in a **dry location only**, grounded and properly protected by an over current device such as a circuit breaker or fuse.

This system is not intended to be used for treating water that is microbiologically unsafe or of unknown quality without adequate disinfection before or after the system.

If conditioner/refiner is being used to reduce barium and/or radium 226 and 228, please verify performance by contacting Legend Technical Services, an independent laboratory, at 1-800-949-8220 for testing treated water supply, or check the water testing section of your local phone directory.

**FCC NOTICE**

**NOTE:** This equipment has been tested and found to comply with the limits for a Class B digital device, pursuant to Part 15 of the **FCC** Rules. These limits are designed to provide reasonable protection against harmful interference in a residential installation. This equipment generates, uses, and can radiate radio frequency energy and, if not installed and used in accordance with the instructions may cause harmful interference to radio communications. However, there is no guarantee that interference will not occur in a particular installation. If this equipment does cause harmful interference to radio or television reception, which can be determined by turning the equipment off and on, the user is encouraged to try to correct the interference by one or more of the following measures:

- Reorient or relocate the receiving antenna.
- Increase the separation between the equipment and receiver.
- Connect the equipment into an outlet on a circuit different from that to which the receiver is connected.
- Consult the dealer or an experienced radio/TV technician for help.

Changes or modifications not expressly approved by EcoWater Systems could void the user's authority to operate the equipment.

This device complies with **Industry Canada** Standard RSS-210. Operation is subject to the following two conditions: (1) this device may not cause interference, and (2) this device must accept any interference, including interference that may cause undesired operation of the device.

Ce dispositif est conforme avec la norme CNR-210 **d'Industrie Canada**. Le fonctionnement du dispositif est sujet aux deux conditions suivantes: (1) le dispositif ne doit pas causer de brouillage, et (2) le dispositif doit accepter tous brouillages, incluant tous brouillages qui peut nuire au bon fonctionnement du dispositif.



European Directive 2002/96/EC requires all electrical and electronic equipment to be disposed of according to Waste Electrical and Electronic Equipment (WEEE) requirements. This directive or similar laws are in place nationally and can vary from region to region. Please refer to your state and local laws for proper disposal of the equipment.

## LIMITED WARRANTY

### **EcoWater Systems LLC Advantage Warranty Series 3700 & 3702 Water Conditioning System**

Congratulations! You have just purchased the highest quality water conditioning product on the market.

**To whom is this warranty extended?**

EcoWater Systems LLC warrants its products to the original owner and guarantees that the products will be free from defects in materials and workmanship from the original date of installation.

**How does my warranty work?**

If, during the respective warranty period, a part proves, after inspection by EcoWater, to be defective, EcoWater will, at its sole option repair or replace that part at no charge, other than normal shipping, installation or service charges.

**What is covered by the warranty?**

EcoWater Systems LLC guarantees that,

for the LIFETIME of the original owner, the SALT TANK and the MINERAL TANK will not rust, corrode, leak, burst, or in any other manner fail to perform their proper functions and that,

for a period of TEN (10) YEARS, the VALVE BODY will be free of defects in materials and workmanship and will perform its proper function and that,

for a period of FIVE (5) YEARS, the ELECTRONIC FACEPLATE and ALL OTHER PARTS, including the HYDROLINK® REMOTE will be free of defects in materials and workmanship and will perform their normal functions.

Only on models designated as ERR on the rating decal, is the MEDIA BED guaranteed, for the LIFETIME of the original owner, to be free of defects in materials and workmanship and to remove chlorine taste and odor from a municipal water supply.

Only on models designated as ERRC on the rating decal, is the MEDIA BED guaranteed, for a period of TEN (10) YEARS, to remove chloramines and chlorine taste and odor from a municipal water supply.

**How do I obtain warranty service?**

Should you need service, your local, independent EcoWater Dealer is only a phone call away.

PHONE: \_\_\_\_\_

To obtain warranty service, notice must be given, within thirty (30) days of the discovery of the defect, to your local EcoWater Systems dealer.

**If I need a part replaced after the factory warranty expires, is the replacement part warranted?**

Yes, EcoWater Systems LLC warrants FACTORY REPAIRS as well as all REPLACEMENT PARTS for a period of 90 DAYS. This warranty does not include normal shipping, installation or service charges.

**Are any additional warranties available?**

We are pleased to say, YES! EcoWater Systems LLC sells an EXTENDED, PARTS ONLY WARRANTY for the ELECTRONICS portion of your product. This warranty is called the "Perfect Ten" and extends the five year warranty on the electronic FACEPLATE, WIRING HARNESS, DRIVE MOTOR, POWER SUPPLY, POWER CORD, SENSOR HOUSING, and MICRO SWITCHES to a total of TEN YEARS from the date of original installation. Your local dealer will provide details regarding this warranty or will refer you to the factory for additional information. In addition, the 3700 SERIES product carries the CREST OF EXCELLENCE GUARANTEE that, should you experience a repetitive problem that remains uncorrected, EcoWater will, during the FIRST YEAR OF INSTALLATION, replace the product with the exact or comparable product.\* This guarantee may be subject to normal shipping and installation or service charges.

**General Provisions**

The above warranties are effective provided the water conditioner/refiner is operated at water pressures not exceeding 125 psi, and at water temperatures not exceeding 120°F (and on a municipal chlorinated water supply - models designated as ERR on the rating decal); provided further that the water conditioner/refiner is not subject to abuse, misuse, alteration, neglect, freezing, accident or negligence; and provided further that the water conditioner/refiner is not damaged as the result of any unusual force of nature such as, but not limited to, flood, hurricane, tornado or earthquake. EcoWater Systems LLC is excused if failure to perform its warranty obligations is the result of strikes, government regulation, materials shortages, or other circumstances beyond its control.

\*THERE ARE NO WARRANTIES ON THE WATER CONDITIONER/REFINER BEYOND THOSE SPECIFICALLY DESCRIBED ABOVE. ALL IMPLIED WARRANTIES, INCLUDING ANY IMPLIED WARRANTY OF MERCHANTABILITY OR OF FITNESS FOR A PARTICULAR PURPOSE, ARE DISCLAIMED TO THE EXTENT THEY MIGHT EXTEND BEYOND THE ABOVE PERIODS. THE SOLE OBLIGATION OF ECOWATER SYSTEMS LLC UNDER THESE WARRANTIES IS TO REPLACE OR REPAIR THE COMPONENT OR PART WHICH PROVES TO BE DEFECTIVE WITHIN THE SPECIFIED TIME PERIOD, AND ECOWATER IS NOT LIABLE FOR CONSEQUENTIAL OR INCIDENTAL DAMAGES. NO ECOWATER DEALER, AGENT, REPRESENTATIVE, OR OTHER PERSON IS AUTHORIZED TO EXTEND OR EXPAND THE WARRANTIES EXPRESSLY DESCRIBED ABOVE.

Some states do not allow limitations on how long an implied warranty lasts or exclusions or limitations of incidental or consequential damage, so the limitations and exclusions in this warranty may not apply to you. This warranty gives you specific legal rights, and you may have other rights which vary from state to state. This warranty applies to consumer-owned installations only.

# Crest of Excellence

## GUARANTEE

for the EcoWater Series 3700 & 3702 Water Conditioning Systems

---

Satisfied customers are our most valuable asset, and EcoWater has been dedicated to the manufacture of the highest quality water conditioning equipment and to the satisfaction of its customers for over 85 years. When you purchase EcoWater equipment you're buying quality; and that is exactly what we expect you to receive!

The Crest of Excellence Performance Guarantee assures you that satisfying customers is our primary concern, and allows you to feel secure and confident with the quality of your purchase.

If during the first year of installation, the unit does not perform the function for which it was designed, and the repetitive problem remains uncorrected, we will – under the Crest of Excellence Performance Guarantee and at no charge to you – replace the unit with identical equipment or with equipment of comparable features and capabilities.

The Crest of Excellence Performance Guarantee applies to new equipment which is purchased and serviced through Authorized EcoWater Dealers, and is not applicable to equipment which is damaged or destroyed by forces of nature, abuse, neglect or misuse.

It's just that easy! Quality and satisfaction are what you are buying and the Crest of Excellence Performance Guarantee is our promise that you'll get what you pay for!

---

For future reference, enter the following information:

**Model No.** \_\_\_\_\_ **Installation Date** \_\_\_\_\_

**Serial No.** (includes date code) \_\_\_\_\_

**Water Hardness** \_\_\_\_\_ **GPG** **Iron Content** \_\_\_\_\_ **PPM**

Model No. and Serial No. are on the shipping carton and on the conditioner/refiner's rating decal.

SPECIFICATIONS					
	ECR3700R20	ERR3700R20	ECR3700R30	ECR3702R30	ERR3702R30
Model Code	HR20	HR20+	HR30	2H30	2H30+
Rated Softening Capacity (Grains @ lb. Salt Dose)	5,700 @ 1.1 16,800 @ 4.3 20,400 @ 7.5	9,800 @ 2.4 18,100 @ 5.6 20,900 @ 8.9	8,300 @ 1.6 25,000 @ 6.4 30,200 @ 11.3	8,300 @ 1.6 25,000 @ 6.4 30,200 @ 11.3	11,600 @ 2.8 22,300 @ 6.9 25,900 @ 11.0
Rated Efficiency (gr./lb. of Salt at Min. Salt Dose)	5,150	4,100	5,160	5,160	4,140
Water Used During Regeneration	4.6 gal./1,000 grains	5.0 gal./1,000 grains	4.5 gal./1,000 grains	4.5 gal./1,000 grains	5.0 gal./1,000 grains
Service Flow Rate (gpm)	9.0	8.0	11.0	11.0	8.0
Pressure Drop at Service Flow Rate (psi)	10	7	8	8	8
Intermittent Flow Rate (gpm) @ 15 psi ▲	12.0	14.8	16.5	16.5	14.2
Intermittent Flow Rate (gpm) @ 30 psi ▲	19.4	23.6	25.8	25.8	21.4
Amount of High Capacity Resin (cu. ft.)	0.60	0.71	0.89	0.89	0.88
Water Supply Max. Hardness (gpg)	40	50	60	60	60
Water Supply Max. Clear Water Iron (ppm) ■	10	10	12	12	12
Min.-Max. Working Pressure (psi) ◆	20 - 125				
Min.-Max. Operating Temperature (°F)	40 - 120				
Min. Water Supply Flow Rate (gpm)	3				
Max. Flow Rate (gpm) to Drain during Recharge	2.4	3.0	3.0	3.0	3.0

SPECIFICATIONS					
	ECR3702R40	ECR3702R50S	ERR3702R50	ECR3702R70	ERRC3702R50 *
Model Code	2H40	2H50	2R50	2H70	2H50+
Rated Softening Capacity (Grains @ lb. Salt Dose)	11,300 @ 2.2 33,200 @ 8.5 40,100 @ 14.8	21,600 @ 4.5 39,500 @ 11.0 50,000 @ 17.4	21,000 @ 4.7 35,300 @ 9.7 49,900 @ 19.5	32,900 @ 6.2 57,600 @ 12.8 71,500 @ 25.6	21,600 @ 4.5 39,500 @ 11.0 50,000 @ 17.4
Rated Efficiency (gr./lb. of Salt at Min. Salt Dose)	5,150	4,800	4,440	5,310	4,800
Water Used During Regeneration	4.7 gal./1,000 grains	3.8 gal./1,000 grains	3.9 gal./1,000 grains	2.9 gal./1,000 grains	3.8 gal./1,000 grains
Service Flow Rate (gpm)	12.0	20.0	10.9	12.0	12.0
Pressure Drop at Service Flow Rate (psi)	13	13	8	11	10
Intermittent Flow Rate (gpm) @ 15 psi ▲	13.6	21.5	15.8	17.0	15.0
Intermittent Flow Rate (gpm) @ 30 psi ▲	21.6	32.2	24.0	22.0	21.0
Amount of High Capacity Resin (cu. ft.)	1.18	1.53	1.56	2.05	1.53
Water Supply Max. Hardness (gpg)	75	95	95	125	95
Water Supply Max. Clear Water Iron (ppm) ■	15	15	15	15	15
Min.-Max. Working Pressure (psi) ◆	20 - 125				
Min.-Max. Operating Temperature (°F)	40 - 120				
Min. Water Supply Flow Rate (gpm)	3				
Max. Flow Rate (gpm) to Drain during Recharge	3.0	4.0	4.0	4.0	4.0

▲ Intermittent flow rate does not represent the maximum service flow rate used for determining the unit's rated capacity and efficiency. Continuous operation at flow rates greater than the service flow rate may affect capacity and efficiency performance. The validity of these flow rates is verified by Water Quality Association (WQA).

■ Capacity to remove clear water iron is substantiated by independent laboratory test data. State of Wisconsin requires additional treatment if water supply contains greater than 5 ppm clear water iron.

◆ Canada working pressure limits: 1.4 - 7.0 kg/cm<sup>2</sup>.

\* Model ERRC3702R50 has not been tested or certified by NSF International or the Water Quality Association.

These units conform to NSF/ANSI 44 for the specific performance claims as verified and substantiated by test data.

These models are efficiency rated. The efficiency rating is valid only at the minimum salt dose and the service flow rate. The softeners have a demand initiated regeneration (D.I.R) feature that complies with specific performance specifications intended to minimize the amount of regenerant brine and water used in their operation.

These softeners have a rated softener efficiency of not less than 3,350 grains of total hardness exchange per pound of salt (based on sodium chloride) and shall not deliver more salt than their listed rating or be operated at a sustained maximum service flow rate greater than their listed rating. These softeners have been proven to deliver soft water for at least ten continuous minutes at the rated service flow rate. The rated salt efficiency is measured by laboratory tests described in NSF/ANSI Standard 44. These tests represent the maximum possible efficiency that the system can achieve. Operational efficiency is the actual efficiency after the system has been installed. It is typically less than the rated efficiency, due to individual application factors including water hardness, water usage, and other contaminants that reduce a softener's capacity.

While testing was performed under standard laboratory conditions, actual performance of the system may vary based on local water conditions.

<b>PERFORMANCE CLAIMS</b>		
<b>Contaminant</b>	<b>Influent Challenge Level</b>	<b>Maximum Allowable Product Water Level</b>
Barium	10 ±10% mg/L	2.0 mg/L
Radium 226/228	25 pCi/L	5 pCi/L

Test parameters include: pH = 7.5 ±0.5, flow rate = 7.5 gpm, and dynamic pressure = 35 ±5 psig.

Models ERR3700R20, ERR3702R30 and ERR3702R50 have been tested according to NSF/ANSI Standard 42 for the reduction of chlorine taste and odor. The concentration of the indicated substance in water entering the system was reduced to a concentration less than or equal to the permissible limit for water leaving the system, as specified in NSF/ANSI Standard 42.

<b>PERFORMANCE CLAIMS</b>		
<b>Substance</b>	<b>Influent Challenge Level</b>	<b>Reduction Requirement</b>
Chlorine	2.0 ±10% mg/L	50%

		<b>Model ERR3700R20</b>	<b>Model ERR3702R30</b>	<b>Model ERR3702R50</b>
Rated Capacity at Chlorine Concentration** of:	0.50 ppm	2,920,000 gal.*	3,650,000 gal.*	4,867,000 gal.*
	0.75 ppm	1,950,000 gal.*	2,440,000 gal.*	3,250,000 gal.*
	1.0 ppm	1,460,000 gal.*	1,820,000 gal.*	2,433,000 gal.*
	1.5 ppm	950,000 gal.*	1,910,000 gal.*	1,583,000 gal.*
	2.0 ppm	730,000 gal.	912,000 gal.*	1,217,000 gal.*

\* From independent laboratory test data.

\*\* Typical residential chlorine concentration is 0.5 to 1.0 ppm.

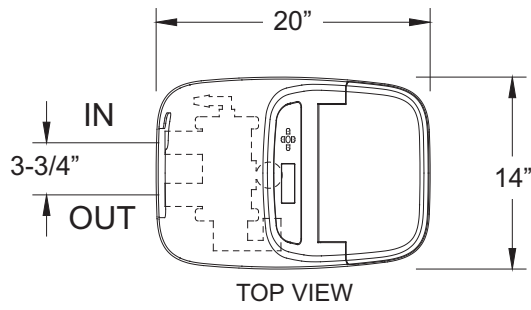
Model ERRC 3702R50 has not been tested or certified by NSF International or the Water Quality Association.

<b>MODEL ERRC3702R50 PERFORMANCE CLAIM</b>		
<b>Substance</b>	<b>Influent Challenge Level</b>	<b>Reduction Requirement</b>
Chloramines	3 mg/L	>70% @ 10 gpm for 34,000 gal.***

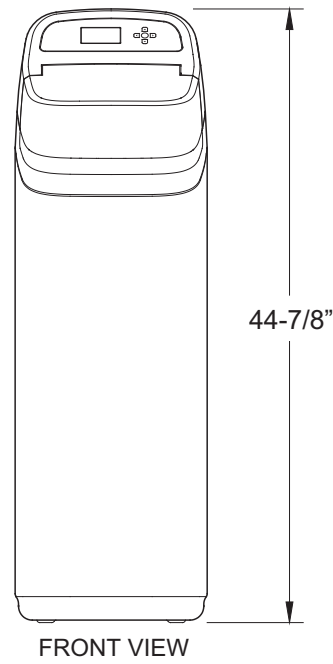
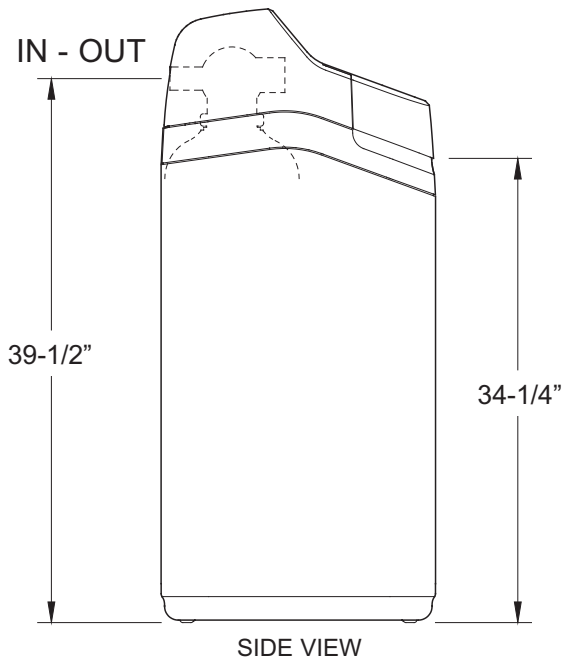
\*\*\* From manufacturer's test data.



**Cabinet Models**



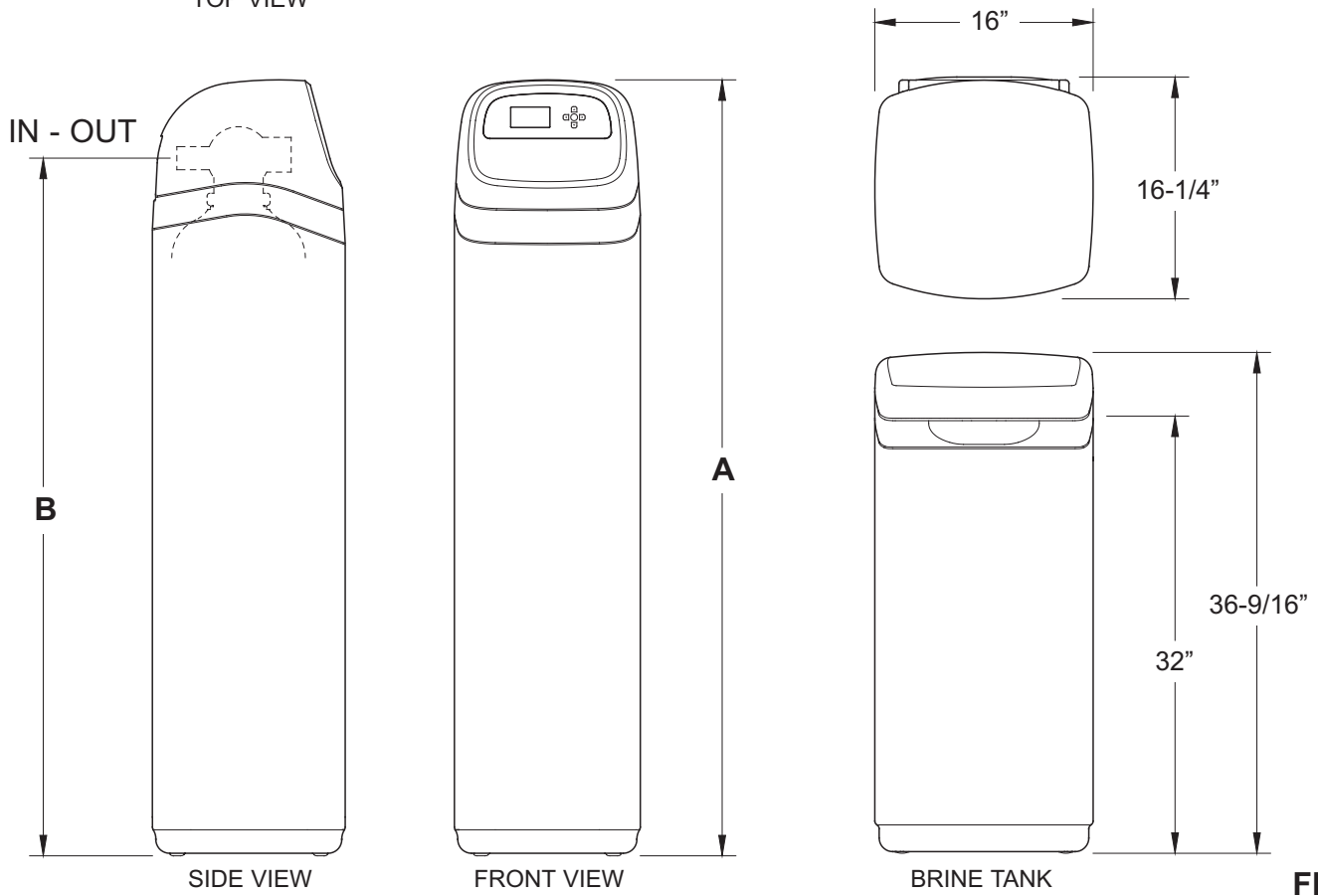
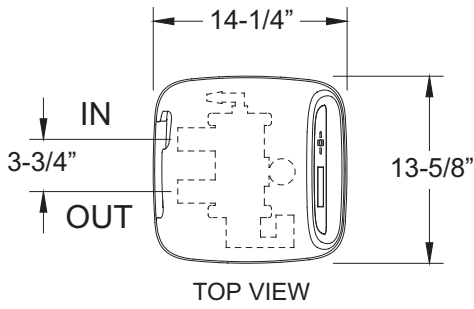
Model	Nominal Resin Tank Size
ECR3700R20	8" dia. x 35"
ECR3700R30	10" dia. x 35"
ERR3700R20	



**FIG. 1**

**Two-Tank Models**

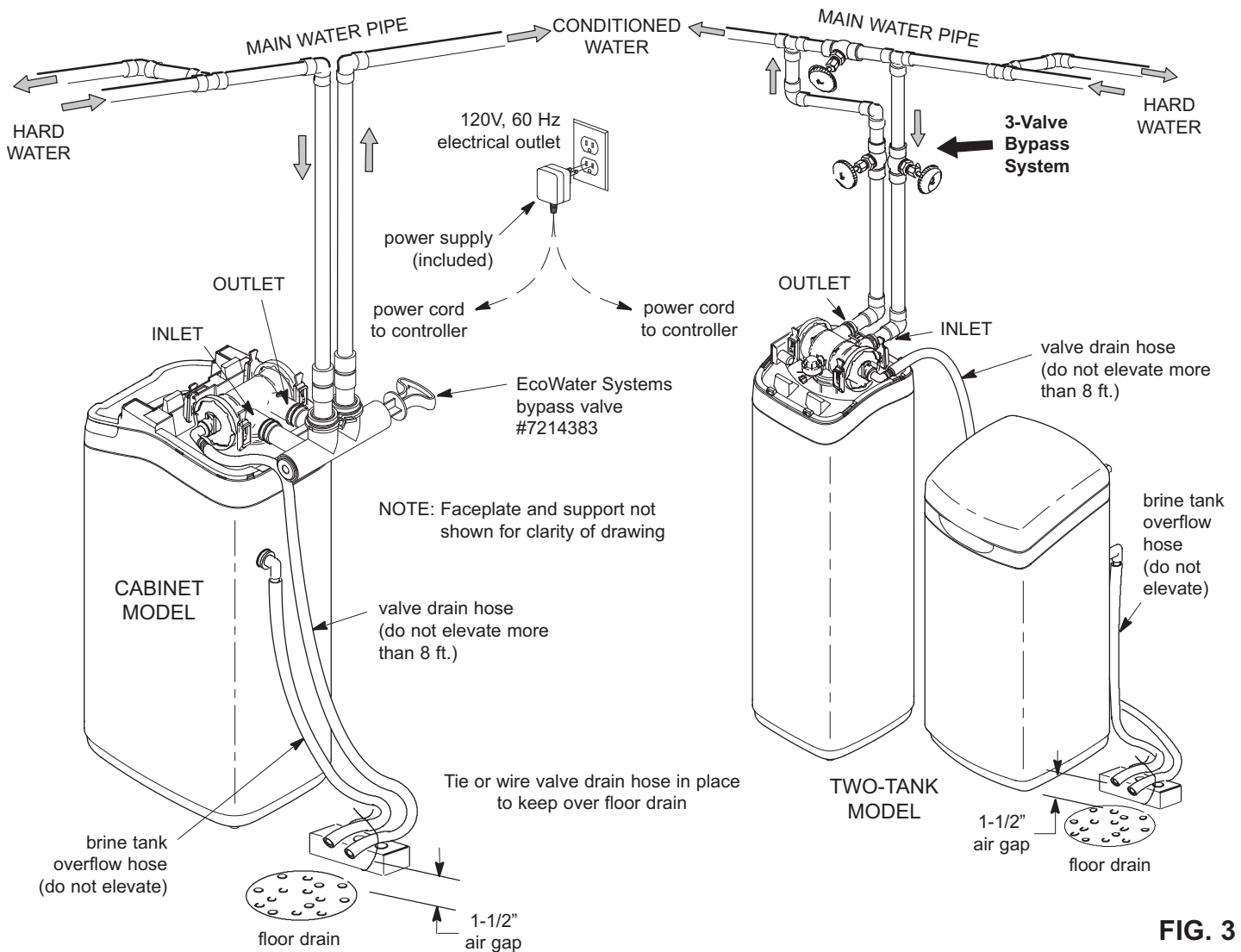
Model	Nominal Resin Tank Size	Dimension A	Dimension B
ECR3702R30	10" dia. x 35"	45"	39-1/8"
ERR3702R30	10" dia. x 47"	57"	51-1/8"
ECR3702R40			
ECR3702R50S	12" dia. x 54"	63"	57-1/8"
ERR3702R50			
ECR3702R70			
ERRC3702R50			



**FIG. 2**



**TYPICAL INSTALLATION ILLUSTRATIONS**



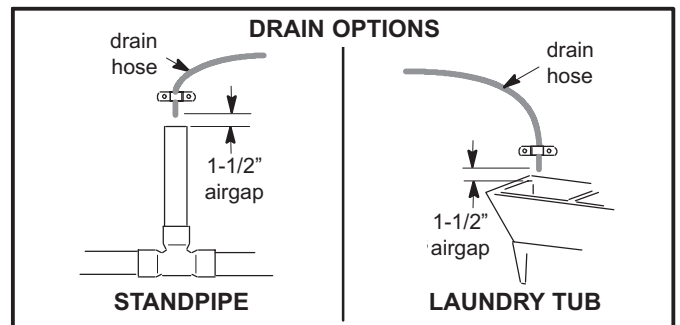
**FIG. 3**

**INLET / OUTLET PLUMBING OPTIONS**

- ALWAYS INSTALL either an EcoWater Systems bypass valve #7214383, or a 3-valve bypass system. Bypass valves allow you to turn off water to the conditioner/refiner for repairs if needed, but still have water in house pipes.

**OTHER REQUIREMENTS**

- A drain is needed for recharge discharge water. A floor drain is preferred, close to the EcoWater Systems conditioner/refiner. A laundry tub, standpipe, etc., are other options (See Figure 3B).
- A 120V, 60 Hz, grounded, continuously "live" electrical outlet is needed, in a dry location near the EcoWater Systems conditioner/refiner.



**FIG. 3B**

## 1. UNPACKING

EcoWater Systems conditioner/refiner models R50 and R70 are shipped from the factory in two cartons. These contain resin tank/controller assembly in one carton and the brine tank, cover, bag(s) of small parts needed to assemble and install the unit, plus this manual, in the other.

EcoWater Systems conditioner/refiner models R20, R30 and R40 are shipped from the factory in one master carton. The carton also includes a bag of small parts needed to assemble and install the unit, plus this manual.

Thoroughly check the EcoWater Systems conditioner/refiner for possible shipping damage and parts loss. Also inspect and note any damage to the shipping carton. Notify the transportation company if damage is present. EcoWater Systems is not responsible for in-transit damages.

Remove and discard (RECYCLE) all packing materials. We suggest you keep the small parts in the bag(s) until you are ready to use them.

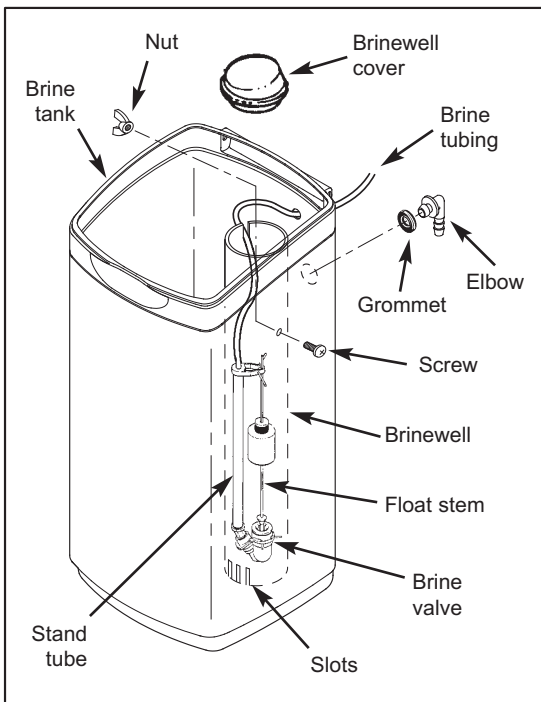
## 2. BRINE TANK (on two-tank models)

a. Place the brinewell into position in the brine tank, with the slots at the bottom, as shown in Figure 4. Align the mounting hole in the brinewell with the corresponding hole in the tank wall. Then use the screw and nut from the parts bag to fasten the brinewell in place.

b. Lower the brine valve into the brinewell. Push the tubing into the brinewell top slot (Fig. 4) and route it out of the brine tank through the smaller hole in the rear wall of the brine tank.

c. Install the brinewell cover.

d. Take the rubber grommet and hose adaptor elbow from the parts bag. Push grommet into the larger hole in the rear wall of the brine tank. Then insert the larger diameter end of the elbow through the grommet.



**FIG. 4**

e. Make sure the brine tank cover is properly positioned on the tank.

## 3. INSTALL BYPASS VALVE and/or COPPER TUBES

a. If installing an **EcoWater Systems Bypass Valve**, put lubricated o-ring seals onto both bypass valve ports (See Figure 5B). Carefully slide the bypass valve into the conditioner/refiner valve and install the "C" clips.

b. Slide a lubricated o-ring seal onto each of the copper tubes. Carefully insert the copper tubes into the bypass valve (See Figure 5B), or into the conditioner/refiner valve (Figures 5 & 5A). Then install the "C" clips.

**NOTE:** For lubrication, use silicone grease approved for potable water supplies.

## 4. TURN OFF WATER SUPPLY

a. Close the main water supply valve near the well pump or water meter.

b. Shut off the electric or fuel supply to the water heater.

c. Open high and low faucets to drain all water from the house pipes.

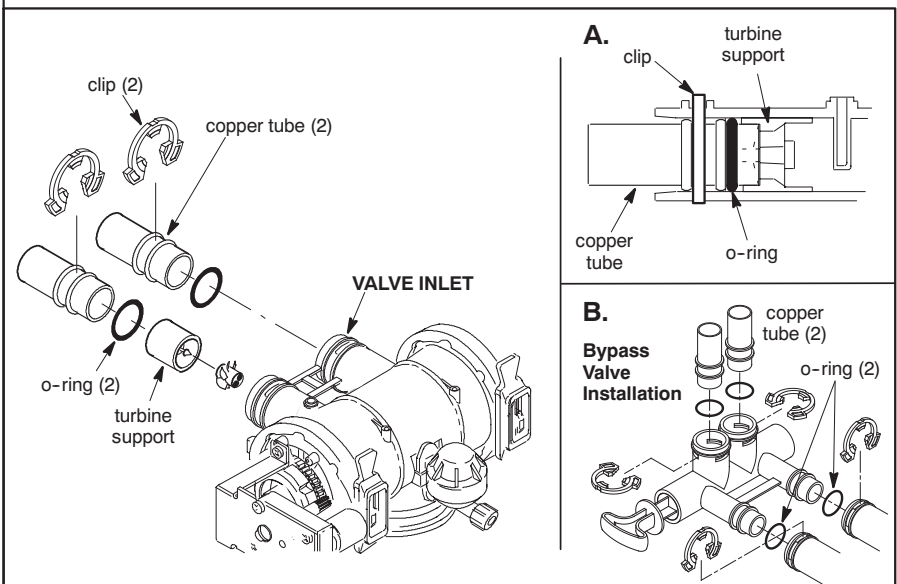
## 5. INSTALLING THREE-VALVE BYPASS

If installing a 3-valve bypass system, plumb as needed using Figure 3 as a guide. When installing sweat copper, be sure to use lead-free solder and flux, required by federal and state codes. Use pipe joint compound on outside pipe threads.

## 6. ASSEMBLE INLET & OUTLET PLUMBING

Measure, cut, and loosely assemble pipe and fittings from the main water pipe (or from the bypass valves installed in Step 5), to the inlet and outlet copper tubes, installed in Step 3b.

Be sure **hard water** supply pipe **goes to the valve inlet side**. Trace the water flow direction to be sure.



**FIG. 5**

**7. CONNECT INLET & OUTLET PLUMBING**

**a. SOLDERED COPPER**

- (1) Thoroughly clean and flux all joints.
- (2) Pull the plastic "C" clips and remove the inlet and outlet tubes from the valve. Remove o-rings from the tubes. **DO NOT solder with tubes in the valve.** Soldering heat will damage the valve.

**NOTE:** If installing a ground as shown in Figure 6A, place ground clamps on copper tubes before soldering (See Step 7a).

- (3) Make all solder connections. Be sure to keep fittings fully together, and pipes square and straight.

**b. THREADED PIPE**

- (1) Apply pipe joint compound to all outside pipe threads.
- (2) Tighten all threaded joints.
- (3) If soldering to the inlet and outlet tubes, observe Step 7a above.

**c. CPVC PLASTIC PIPE**

- (1) Clean, prime and cement all joints, following the manufacturer's instructions supplied with the plastic pipe and fittings.
- (2) If soldering to the inlet and outlet tubes, observe Step 7a above.

**8. COLD WATER PIPE GROUNDING**

The house cold water pipe (metal only) is often used as a ground for the house electrical system. The 3-valve bypass type of installation, shown in Figure 3, will maintain ground continuity. If you use the plastic bypass, continuity is broken. To restore the ground, do either step **8a** or **8b** following.

- a.** Use the EcoWater ground clamp kit (not included) to make a jumper across the inlet and outlet pipes (See Figure 6A).

- b.** Install a #4 copper wire across the removed section of main water pipe, securely clamping at both ends (See Figure 6B) – parts not included.

**9. INSTALL VALVE DRAIN HOSE**

**NOTE:** See valve drain options on Page 9.

- a.** Elevating the drain hose may cause back pressure that could reduce the brine draw during recharge. If raising the drain line overhead is required to get to the drain point, measure the inlet water pressure to the conditioner/refiner first. For inlet pressures between 20 and 50 psi, do not raise higher than 8 feet above the floor. For inlet pressure above 50 psi, the drain line may be raised to a maximum height of 14 feet.

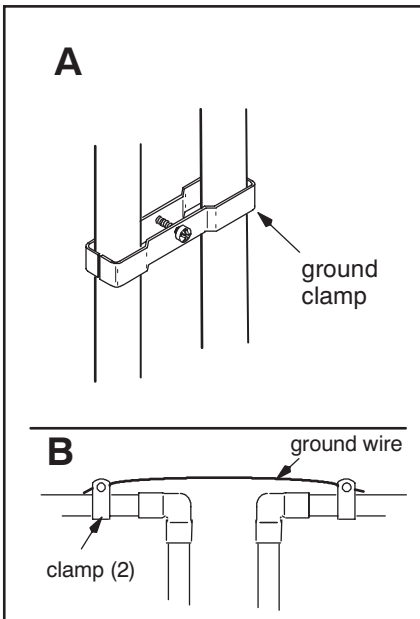
- b.** Connect a length of 1/2" I.D. hose (check codes) to the valve drain elbow, on the controller. Use a hose clamp to hold the hose in place. Route the hose out through the notch in the back of the top cover.

- c.** Run the hose to the floor drain, and as typically shown in Figure 3, tie or wire the end to a brick or other heavy object. This will prevent "whipping" during recharges. Be sure to provide a 1-1/2" minimum air gap, to prevent possible sewer water backup.

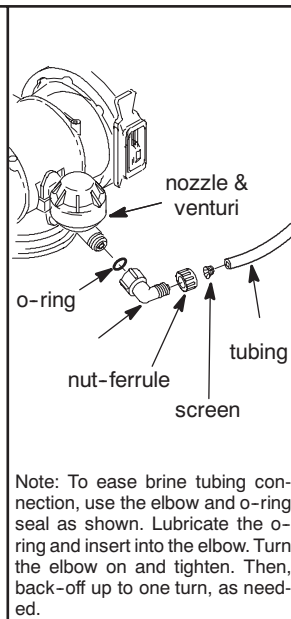
**10. INSTALL BRINE TANK OVERFLOW HOSE**

- a.** Connect a length of 1/2" I. D. hose to the brine tank overflow elbow and secure in place with a hose clamp.
- b.** Run the hose to the floor drain, or other suitable drain point **no higher than the drain fitting** on the tank. If the tank overfills with water, the excess water flows to the drain point.

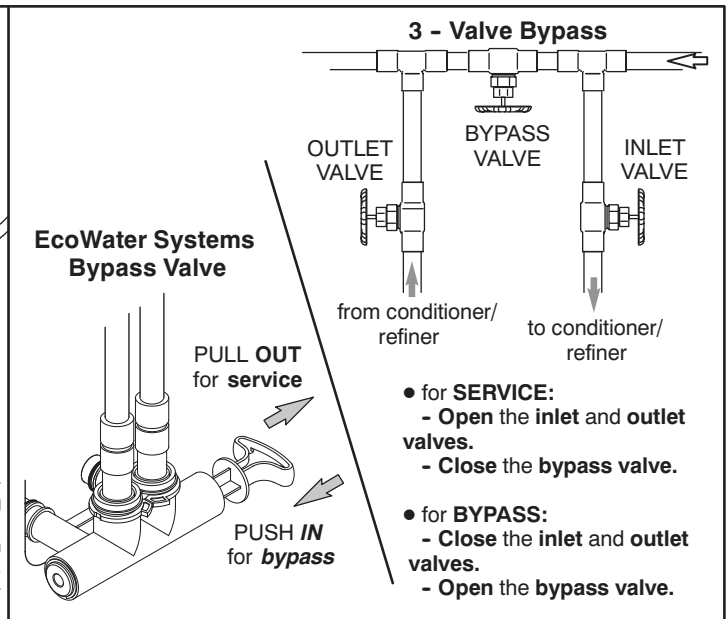
- 11. On Two-tank models,** connect the brine tubing to the nozzle and venturi housing.



**FIG. 6**



**FIG. 7**



**FIG. 8**

## 12. PRESSURE TESTING FOR LEAKS, PROGRAMMING THE CONTROLLER & RINSING THE MEDIA

To prevent excessive air pressure in the EcoWater Systems conditioner/refiner and plumbing system, do the following steps EXACTLY in order:

- a. Fully open two or more **conditioned** cold water faucets nearby the EcoWater Systems conditioner/refiner.
- b. Place the bypass valve(s) in **bypass** position (See Figure 8).
- c. Fully open the main water supply valve. Watch until the flow from the opened faucets becomes steady, with no spurting or air bubbles.
- d. After about three minutes, open a hot water faucet for one minute, or until all air is expelled.
- e. Close all faucets and check your plumbing work for leaks.
- f. Make sure the conditioner/refiner's valve drain hose is hooked up and the open end directed to a floor drain, laundry tub or other suitable type of drain.
- g. Make sure the conditioner/refiner's bypass valve is in the **bypass** position.
- h. Plug in the power supply.
- i. **Program the electronic controller:** Follow the Setup Procedure on Pages 13-15 for a Wi-Fi system (or Page 17 for a non-Wi-Fi system) to program the electronic controller with basic operating information, such as time and water hardness. After completing the setup procedure, continue with "j. Start a recharge", below.
- j. **Start a recharge:** From the rolling status screens, press the SELECT (○) button to display the **Main menu**. Make sure **Recharge** is highlighted, then press SELECT (○). Press DOWN (▼) to scroll to **Recharge now**, then press SELECT (○) twice. You should hear the valve motor run as the conditioner/refiner begins recharging. Use the RIGHT (▶) button to advance the valve to the **backwash** position.
- k. Once the unit is in backwash, place bypass valve(s) into the **service** position, as follows:
  - (1) SINGLE BYPASS VALVE: **Slowly** move the valve stem toward **service** position, pausing several times to allow the unit to pressurize slowly.
  - (2) 3-VALVE BYPASS: Fully close the **bypass** valve and open the **outlet** valve. **Slowly** open the **inlet** valve, pausing several times to allow the unit to pressurize slowly.
- l. Let the conditioner/refiner complete the backwash and fast rinse cycles (takes 10-12 minutes). When the recharge cycle ends, the conditioner/refiner valve returns to the service position.

## 13. ADD WATER AND SALT TO THE BRINE TANK

- a. Using a pail or garden hose, add about 3 gallons of water into the brine tank. DO NOT pour into the brinewell.
- b. Add salt to the brine tank. It is recommended to fill the brine tank no more than 1/2 full. Level the salt when finished adding. You can use most water conditioner salts, but it must be clean. Recommended nugget, pellet or coarse solar salts have less than 1% impurities.

**NOTE:** See page 42 for additional information on salt.

## 14. SANITIZING THE ECOWATER SYSTEMS CONDITIONER/REFINER

Care is taken at the factory to keep your EcoWater Systems conditioner/refiner clean and sanitary. However, during shipping, storage, installing and operating, bacteria could get into the unit. For this reason, sanitizing as follows is suggested\* when installing.

- a. Remove the brinewell cover and pour about 1-1/2 oz. (2 to 3 tablespoons) of common household bleach into the conditioner/refiner brinewell. Replace the brinewell cover.
- b. Make sure the bypass valve is in the **service** position.
- c. **Start a recharge:** From the rolling status screens, press the SELECT (○) button to display the **Main menu**. Make sure **Recharge** is highlighted, then press SELECT (○). Press DOWN (▼) to scroll to **Recharge now**, then press SELECT (○) twice. You should hear the valve motor run as the conditioner/refiner begins recharging. This recharge draws the sanitizing bleach into and through the conditioner/refiner. Any air remaining in the unit is purged to the drain.
- d. After the recharge has completed, fully open a cold water faucet, downstream from the conditioner/refiner, and allow 50 gallons of water to pass through the system. This should take at least 20 minutes. Close the faucet.

## 15. RESTART THE WATER HEATER

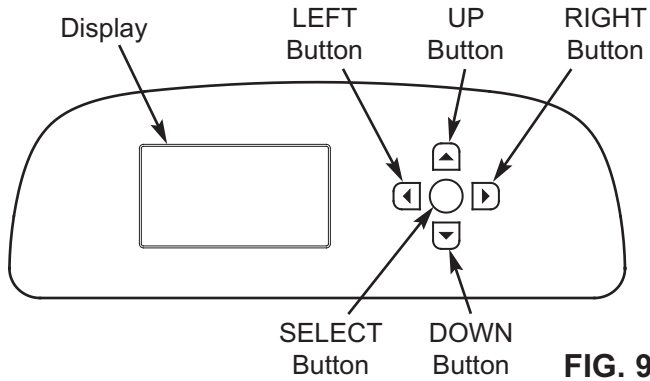
Turn on the electric or fuel supply to the water heater, and light the pilot, if applies.

**NOTE:** The water heater is filled with hard water and, as hot water is used, it refills with conditioned water. In a few days, the hot water will be fully conditioned. To have fully conditioned hot water immediately, wait until the recharge (Step 14) is complete, then drain the water heater until water runs cold.

## 16. NON-WI-FI SYSTEMS ONLY: REMOTE

If your system includes a remote, see Pages 17-27 for setup procedure, remote unpacking, connecting and operating instructions.

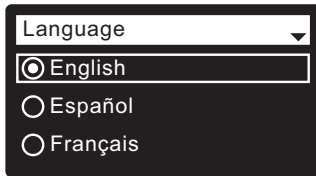
\*Recommended by the Water Quality Association. On some water supplies, the EcoWater Systems unit may need periodic disinfecting.



**FIG. 9**

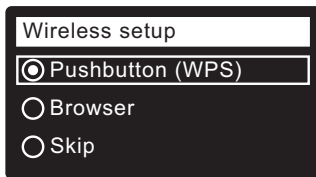
**SETUP PROCEDURE**

When the EcoWater Systems conditioner/refiner is plugged in for the first time, a beep sounds and the display briefly shows a logo, followed by model information. Next, a series of “wizard” screens prompts you to enter basic operating information:



**FIG. 10**

- 1. LANGUAGE** If the desired language already has a dot next to it (See Figure 10), go to Step 2. Otherwise, press the conditioner/refiner’s DOWN (▼) or UP (▲) buttons to scroll to the desired language, then press the SELECT (○) button to choose it.
- Press the SELECT (○) button to advance to the next “wizard” screen.



**FIG. 11**

**NOTE:** Wireless Setup can also be done after the rest of the Setup Procedure (Steps 16-28) has been completed. From the **Main menu**, go down to the **Advanced settings** menu and select **Wireless setup**.

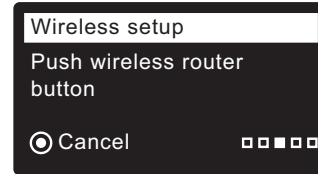
- 3. WIRELESS SETUP** Choose how you will connect the softener to your home’s wireless network:  
**Browser:** You can connect using the browser on your laptop, tablet or phone. Skip to Step 7.

**OR**

**Pushbutton:** If your wireless router has a **WPS** (Wi-Fi Protected Setup) or **Push to Connect** button, you can use this method to connect. Proceed to Step 4.

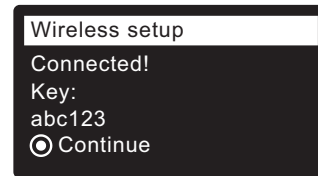
**Pushbutton (WPS) Option**

- Use the SELECT (○) button to choose **Pushbutton (WPS)**. The softener display will change to show “Push wireless router button”.



**FIG. 12**

- Press the WPS or Push to Connect button on your router and wait for a minute or two to see if the display changes again to “Connected” and gives you a key code. If not, you may need to cancel and use the browser option.



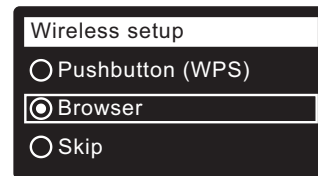
**FIG. 13**

- Once the key code is displayed, write it down. It will be used when you register your system on the EcoWater web site. Proceed to Step 16 on the next page.

**NOTE:** If the “Connected” message shows “-----” (dashes) instead of a key code, it may be that your router is not connected to the internet. Verify that the router’s internet connection works with your laptop or other device.

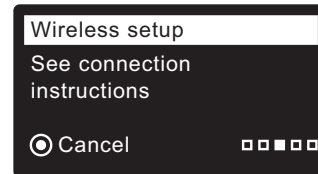
**Browser Option**

- Press the conditioner/refiner’s DOWN (▼) button to scroll to **Browser**.



**FIG. 14**

- Press the SELECT (○) button twice. The softener display will change to show “See connection instructions”.



**FIG. 15**

continued on the next page



continued from the previous page

- On your laptop, tablet or phone, activate the view of wireless networks in range. For example, on a laptop, look for and click on the wireless icon along the lower right edge of the screen. On a phone, you should go into "Settings" and look for "Wi-Fi".



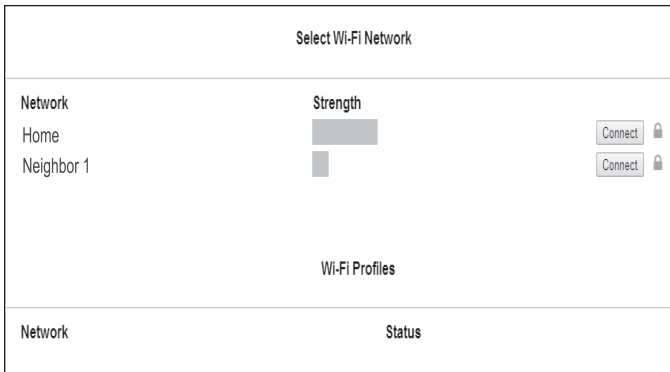
**FIG. 16**

- You should see a network named "H2O-" followed by 12 characters. Select this network to connect your device with it.

- Once your device indicates that it is connected to the H2O network, go to your internet browser (Chrome, Firefox, Internet Explorer, etc.) and type in this URL:

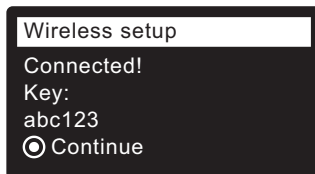
**192.168.0.1**

then click Go or press Enter.



**FIG. 17**

- After a screen like the one shown above appears, select your in-home wireless network and enter the correct password.
- The softener display should change to "Connected" and give you a key code.



**FIG. 18**

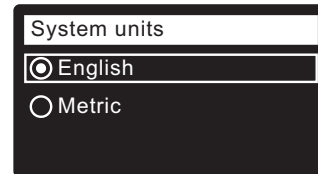
- Once the key code is displayed (it may take a few seconds), write it down. It will be used when you register your system on the EcoWater web site.

**NOTE:** If the "Connected" message shows "-----" (dashes) instead of a key code, it may be that your router is not connected to the internet. Verify that the router's internet connection works with your laptop or other device.

- On your laptop, tablet or phone, go back to the view of networks in range, and make sure that your device is connected back to your local network.

### Finish Setting up the Softener

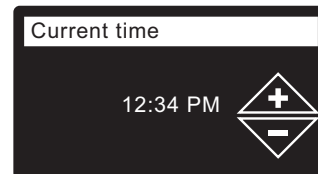
- Once you have connected the Wi-Fi system and written down your key code, press the SELECT (O) button to advance to the next "wizard" screen.



**FIG. 19**

- SYSTEM UNITS** If the desired system already has a dot next to it (See Figure 19), go to Step 18. Otherwise, press the DOWN (▼) or UP (▲) buttons to scroll to the desired system, then press the SELECT (O) button to choose it.

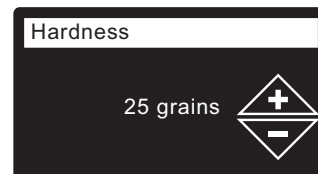
- Press the SELECT (O) button.



**FIG. 20**

- CURRENT TIME** Press the DOWN (▼) or UP (▲) buttons to set the current time (See Figure 20). Hold the button down to rapidly advance. Be sure that AM or PM is correct. If the system units were set to metric in Step 17, the clock will be in 24-hour format.

- Press the SELECT (O) button.

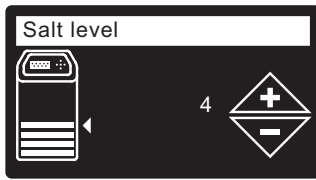


**FIG. 21**

- HARDNESS** Press the UP (▲) or DOWN (▼) buttons to set the value of your water's hardness (See Figure 21).

**NOTE:** Do not increase the hardness setting to compensate for iron in your water. The electronic control compensates automatically after you set the iron level in Step 25, below.

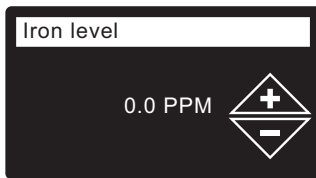
22. Press the SELECT (O) button.



**FIG. 22**

23. **SALT LEVEL (Two-Tank models only - skip to Step 25 for other models)** Press the UP (▲) or DOWN (▼) buttons to set the salt level (See Figure 22). It should match the lowest number visible on the brinewell above the salt.

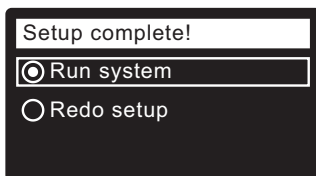
24. Press the SELECT (O) button.



**FIG. 23**

25. **IRON LEVEL** Press the UP (▲) or DOWN (▼) buttons to set the value for iron in your water (See Figure 23). The conversion factor is 3 grains per 1 ppm of clear water iron.

26. Press the SELECT (O) button. The screen will show “Setup complete!” (See Figure 24).



**FIG. 24**

27. If, at this point, you want to go back and make changes, press the DOWN (▼) button to scroll to **Redo setup**, then press the SELECT (O) button twice to repeat the “wizard” screens.

28. If no changes are desired, make sure **Run system** has a dot next to it (See Figure 24) and press the SELECT (O) button. The unit begins normal operation, described on Page 28.

## HOW TO REGISTER A SYSTEM ON THE ECOWATER WEB SITE AS A DEALER

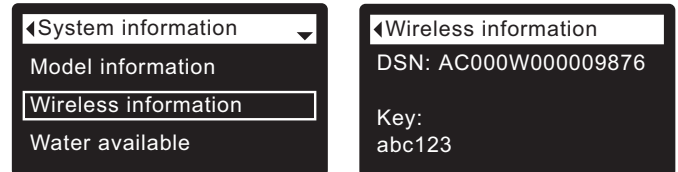
**NOTE:** A dealer registering softeners must log in as a dealer, not as a customer.

29. In your internet browser, type in this URL:

**<http://wifi.ecowater.com>**

30. If you are a dealer, and have an account, log in to your account and go to the next step. If you are a customer, go to Page 16 for instructions to create an account and register.

31. After you’ve logged in to your dealer account, click “Add New Customer System” and then enter the key code that you wrote down earlier. If you wait too long between writing down the key code and registering (an hour or less), the code may change. This is a security feature. Look up the new key code, as described in the following note.



**FIG. 25**

**NOTE:** You can look up the current key code on your softener’s controller. From the **Main menu**, go down to the **System information** menu and select **Wireless information**.

32. After you’ve entered the key code in the **Add System** screen, click the “Connect” button to advance to the **Customer Information** screen.

33. Fill in the customer information (address, e-mail, etc.). When entering a password, either have the customer enter their own, or enter one for them and give it to them. If you intend to share the system, sharing needs to be done from the customer’s account (See “How to Share a System” on the following page). When finished filling in the customer information screen, click the “Save and Continue” button.

**NOTE:** When filling in address information, be sure to select the country before attempting to select a state or province.

34. Fill in the **System Settings** screen and click the “Save Settings” button.

35. Fill in the **Dealer Communication Preferences** screen and click the “Save and Continue” button.

36. The message “Customer System Setup Complete” should appear, along with the customer’s account screen. At this point you can make changes or add another system for this customer. When everything is correct, return to the dealer Home page by clicking the “Home” tab along the top of the page.

36. On the dealer Home page, the new system you set up should appear on the systems list.

**NOTE:** On the dealer Home page, the number of shared systems is displayed below the bar along the top of the screen. You can display only shared systems by clicking “shared with you”, and display all systems again by clicking the “Home” tab. See the following page for instructions on how to share a system.



**HOW TO CREATE AN ACCOUNT AND REGISTER YOUR SYSTEM ON THE ECOWATER WEB SITE AS A CUSTOMER**

**NOTE:** A dealer registering softeners must log in as a dealer, not as a customer.

1. In your internet browser, type in this URL:  
**http://wifi.ecowater.com**
2. If you are a new customer, click on “Create Account” to advance to the **Create Your Account** screen.
3. Fill in the account information (e-mail, password, language, etc.). Agree to the Terms of Use, and then click the “Create Account” button to advance to the **Customer Information** screen.
4. Fill in the customer information (name, address, etc.). When finished filling in the customer information screen, click the “Save and Continue” button.

**NOTE:** When filling in address information, be sure to select the country before attempting to select a state or province.

5. Follow the instructions on the **Verify e-mail** screen. You will shortly receive an e-mail confirming that you have created your account. Open this e-mail and click on the link it contains. Your browser will be directed to a **Verification Complete** screen.
6. Now that you have created your account, you may log in. In the verification screen, click the “logging in” link (or go to **http://wifi.ecowater.com**).
7. Log in with the e-mail and password that you entered when creating your account.
8. After you’ve created and logged in to your account, the **Add System** screen will appear. Enter the key code that you wrote down earlier. If you wait too long between writing down the key code and registering (an hour or less), the code may change. This is a security feature. Look up the new key code, as described in the following note.



**FIG. 26**

**NOTE:** You can look up the current key code on your softener’s controller. From the **Main menu**, go down to the **System information** menu and select **Wireless information**.

9. After you’ve entered the key code in the **Add System** screen, click the “Connect” button to advance to the **System Settings** screen.
10. Fill in the **System Settings** screen and click the “Save Settings” button.
11. Fill in the **Communication Preferences** screen and click the “Save and Continue” button.
12. The screen should change to show the Home page for your system, including the softener “dashboard”. Click the “Log Out” tab when you are done.

**VISITING YOUR CUSTOMER ACCOUNT**

Any time after your customer account has been created and system registered, you can visit your account to see your softener “dashboard”, change settings, etc. Direct your browser to **http://wifi.ecowater.com** and log in using the e-mail and password that were specified when setting up the account.

**HOW TO SHARE A SYSTEM BETWEEN A DEALER AND CUSTOMER**

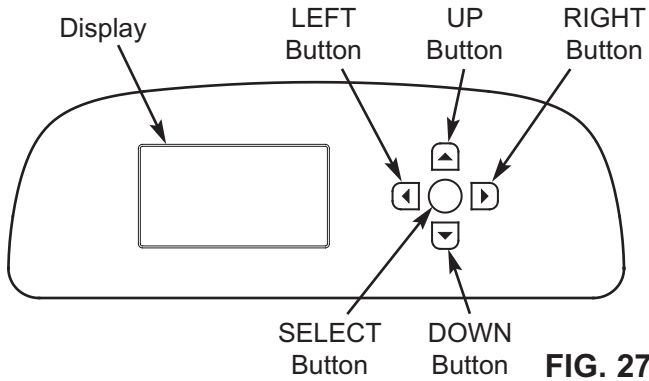
**NOTE:** A system can only be shared from a customer’s account, not a dealer’s.

Systems can be “shared” between a dealer and customer. If a system is shared, the dealer has full access to the displays and settings for that system on the EcoWater Wi-Fi web site. If a system is not shared, the dealer only has access to the “Dealer Communication Preferences” screen for that system.

Once a customer account has been created by a dealer, a customer can grant a dealer access to their system. Access can only be granted to the dealer who sold that system.

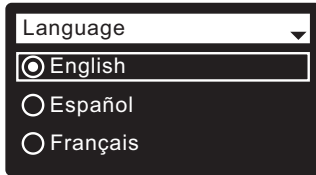
With permission, a dealer (but only the one who sold the system) could also grant it for the customer. To do so, a dealer must log in as a customer rather than as a dealer, using the customer’s e-mail and password (which were entered when the customer account was created).

1. Go to **http://wifi.ecowater.com** and log in (customer’s e-mail and password, not dealer’s).
2. Click on the “Support” tab along the top of the customer Home page.
3. On the **Support** screen, click the “Grant Access” button. It should change to read “Revoke Access”.
4. The system is now shared. Click the “Log Out” tab when you are done.



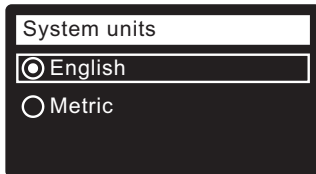
**SETUP PROCEDURE**

When the EcoWater Systems conditioner/refiner is plugged in for the first time, a beep sounds and the display briefly shows a logo, followed by model information. Next, a series of “wizard” screens prompts you to enter basic operating information:



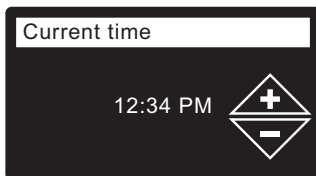
**FIG. 28**

- 1. LANGUAGE** If the desired language already has a dot next to it (See Figure 28), go to Step 2. Otherwise, press the conditioner/refiner’s DOWN (▼) or UP (▲) buttons to scroll to the desired language, then press the SELECT (○) button to choose it.
- Press the SELECT (○) button to advance to the next “wizard” screen.



**FIG. 29**

- 3. SYSTEM UNITS** If the desired system already has a dot next to it (See Figure 29), go to Step 4. Otherwise, press the DOWN (▼) or UP (▲) buttons to scroll to the desired system, then press the SELECT (○) button to choose it.
- Press the SELECT (○) button.



**FIG. 30**

- 5. CURRENT TIME** Press the DOWN (▼) or UP (▲) buttons to set the current time (See Figure 30). Hold the button down to rapidly advance. Be sure that AM or PM is correct. If the system units were set to metric in Step 3, the clock will be in 24-hour format.

- Press the SELECT (○) button.

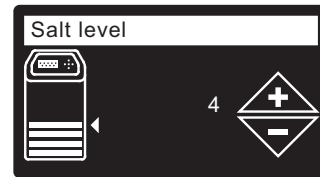


**FIG. 31**

- 7. HARDNESS** Press the UP (▲) or DOWN (▼) buttons to set the value of your water’s hardness (See Figure 31).

**NOTE:** Do not increase the hardness setting to compensate for iron in your water. The electronic control compensates automatically after you set the iron level in Step 11, below.

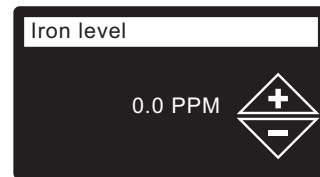
- Press the SELECT (○) button.



**FIG. 32**

- 9. SALT LEVEL (Two-Tank models only - skip to Step 11 for other models)** Press the UP (▲) or DOWN (▼) buttons to set the salt level (See Figure 32). It should match the lowest number visible on the brinewell above the salt.

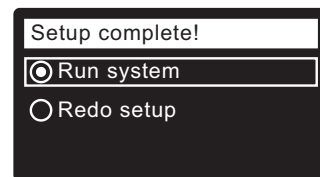
- Press the SELECT (○) button.



**FIG. 33**

- 11. IRON LEVEL** Press the UP (▲) or DOWN (▼) buttons to set the value for iron in your water (See Figure 33). The conversion factor is 3 grains per 1 ppm of clear water iron.

- Press the SELECT (○) button. The screen will show “Setup complete!” (See Figure 34).



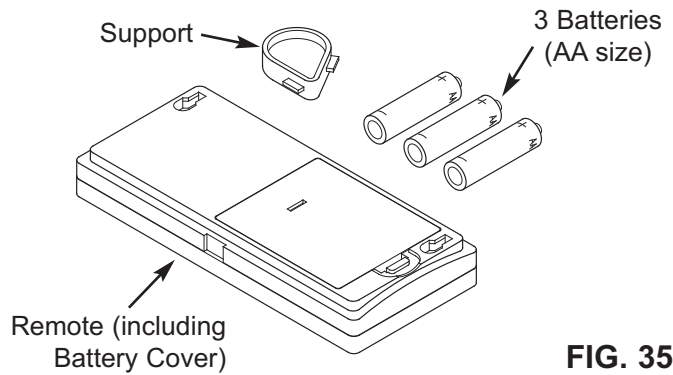
**FIG. 34**

- If, at this point, you want to go back and make changes, press the DOWN (▼) button to scroll to **Redo setup**, then press the SELECT (○) button twice to repeat the “wizard” screens.
- If no changes are desired, make sure **Run system** has a dot next to it (See Figure 34) and press the SELECT (○) button. The unit begins normal operation, described on Page 28.

**UNPACKING**

The EcoWater Systems HydroLink® remote is shipped from the factory in one carton. Thoroughly check for possible shipping damage and parts loss. Also note any damage to the shipping carton. Notify the transportation company if damage is present. EcoWater Systems is not responsible for in-transit damages. Remove and discard (RECYCLE) all packing materials.

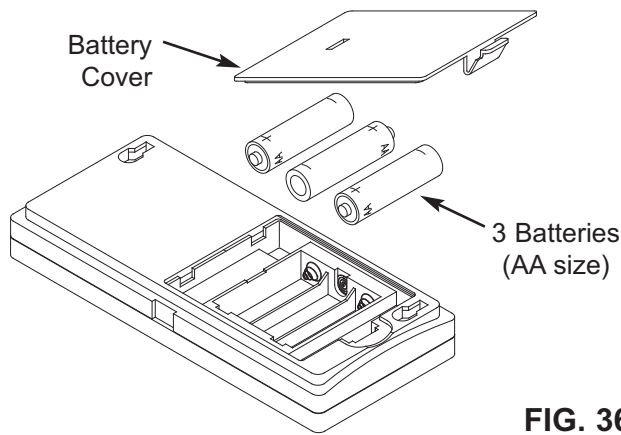
**ITEMS INCLUDED WITH SHIPMENT**



**FIG. 35**

**INSTALLING BATTERIES**

1. Remove the battery cover from the back of the remote.
2. Install three (3) AA size batteries, making sure that they are oriented to match the + and - markings inside the battery compartment (See Figure 36).
3. Snap the battery cover back in place.



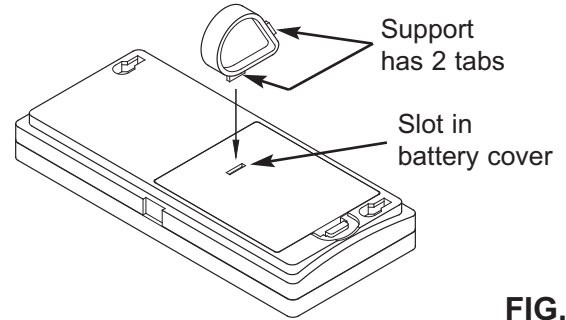
**FIG. 36**

**NOTE:** When replacing batteries in a remote that was previously connected to a conditioner/refiner, it is not necessary to reconnect the remote and conditioner/refiner.

**INSTALLING THE SUPPORT**

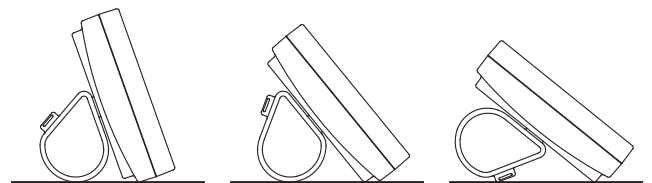
The EcoWater Systems HydroLink® remote is shipped with a teardrop-shaped support to hold the unit at an angle when placed on a horizontal surface.

1. Snap one of the support's two tabs into the rectangular slot on the back of the remote's case (See Figure 37).



**FIG. 37**

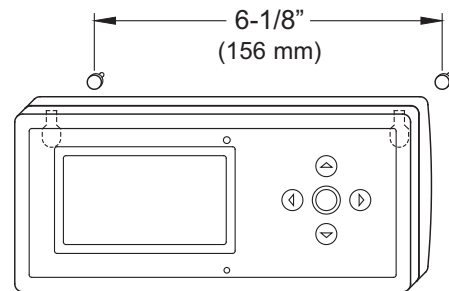
2. The angle may be adjusted by reorienting the support in the battery cover (See Figure 38).



**FIG. 38**

**OPTIONAL WALL MOUNTING**

The EcoWater Systems HydroLink® remote (without the support) may also be mounted on a wall. If this option is desired, install two fasteners (not included) at a convenient height, spaced 6-1/8" (156 mm) apart (See Figure 39).

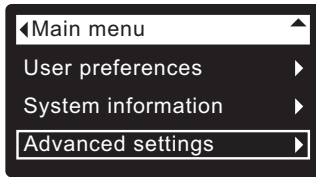


**FIG. 39**

**CONNECTING TO REMOTE**

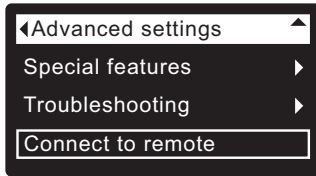
When the conditioner/refiner’s electronic control is first powered up, it is not yet in communication with the remote. Do the following to establish a link between the two:

1. This procedure involves pushing buttons on both the conditioner/refiner and remote, so have the remote near the conditioner/refiner for now. Make sure the remote is powered up (See “Installing Batteries” on Page 18).
2. From any of the rolling status screens, press the conditioner/refiner’s SELECT (O) button to display the **Main menu**.
3. Press the conditioner/refiner’s DOWN (▼) button to scroll through the menu options until **Advanced settings** is highlighted (See Figure 40).



**FIG. 40**

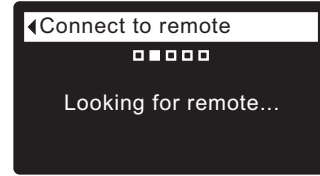
4. Press the conditioner/refiner’s SELECT (O) button to display the Advanced settings menu (See Figure 41).



**FIG. 41**

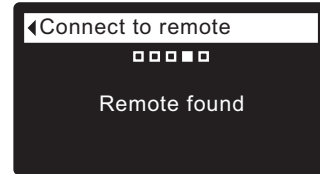
5. Press the conditioner/refiner’s DOWN (▼) button to scroll through the menu options until **Connect to remote** is highlighted.
6. If the remote does not already show a menu screen, press the remote’s SELECT (O) button to display a **Menu** screen. (See Figure 45 on the next page).
7. Press the remote’s DOWN (▼) button to scroll through the menu options until **Add new device** is highlighted in a box (See Figure 46).
8. Press the remote’s SELECT (O) button, and the “Waiting for new device...” screen appears (See Figure 47). The remote waits two minutes for the conditioner/refiner to be activated (in the next step).
9. Make sure the conditioner/refiner’s display still shows the screen in Figure 41. Press the conditioner/refiner’s SELECT (O) button to display the “Looking for remote” screen (See Figure 42).

continued



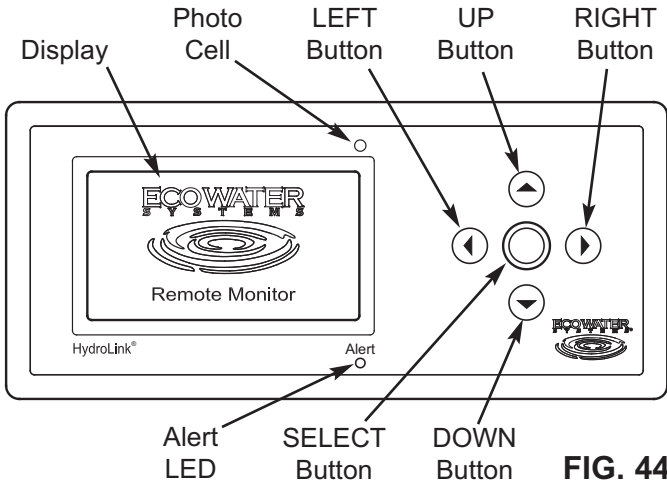
**FIG. 42**

10. Within a few seconds the screen should change to show “Remote found” (See Figure 43). If, after about one minute, the conditioner/refiner’s screen instead reads “New remote not found,” press the conditioner/refiner’s SELECT (O) button to return to the screen in Figure 41 and press the remote’s LEFT (◀) button to return to the screen in Figure 46. Then repeat this procedure from Step 8. If the remote is not found after several tries, contact your dealer for service. Take note of the message on the remote’s screen after an unsuccessful attempt, as it indicates the nature of the problem.



**FIG. 43**

11. Press the conditioner/refiner’s SELECT (O) button. The display will go back to the Advanced settings menu (Figure 41).
12. Press the conditioner/refiner’s LEFT (◀) button twice to return to the rolling status screens.



**FIG. 44**

**REMOTE MENUS**

**Startup Menu**

Before any devices have been added to the remote, the following menu is displayed:

- **Display options**
  - **Set language** (See Page 22)
- **Network options**
  - **Add new device** (See Page 20)

**Conditioner/Refiner Menu**

After the conditioner/refiner has been added, the remote will display a conditioner/refiner status screen as one of the rolling status screens. Pressing the remote's SELECT (O) button when the conditioner/ refiner status screen is displayed shows the following menu:

- **Remote Control**
  - **Recharge** (See Page 23)
  - **Recharge time** (See Page 24)
- **Display options**
  - **Display data** (See Page 24)
  - **Display order** (See Page 25)
  - **Remote control data** (See Page 26)
  - **Rename device** (See Page 26)
  - **Set language** (See Page 22)
- **Network options**
  - **Add new device** (See Page 20)
  - **Delete current device** (See Page 27)
  - **RF signal strength** (See Page 22)

**Drinking Water Status Menu**

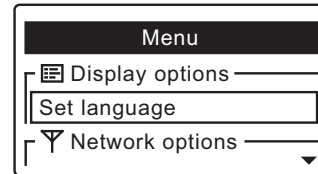
If no drinking water system has been added, the remote will display a drinking water status screen as one of the rolling status screens. Pressing the remote's SELECT (O) button when the drinking water status screen is displayed shows the following menu:

- **Display options**
  - **Drinking water message** (See Page 23)
  - **Set language** (See Page 22)
- **Network options**
  - **Add new device** (See Page 20)

**ADDING A DEVICE**

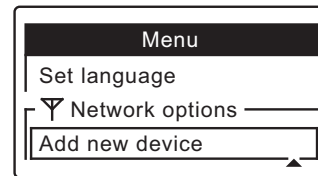
To initiate communication between the remote and a device such as a conditioner/refiner, it is necessary to add the device to the remote by doing the following:

1. If no device has been added to the remote, the menu shown in Figure 45 is displayed instead of status screens. In this case, skip to step 2. Otherwise, if status screens are shown, press the remote's SELECT (O) button to display a **Menu** screen (See Figure 45).



**FIG. 45**

2. Press the DOWN (▼) button to scroll through the menu options until **Add new device** is highlighted in a box (See Figure 46).



**FIG. 46**

3. Press the SELECT (O) button, and the screen shown in Figure 47 appears. The remote waits two minutes for the device to be activated (following the instructions in that device's manual). For complete instructions on adding the conditioner/refiner, refer to "Connecting to Remote" on Page 19 of this manual.



**FIG. 47**

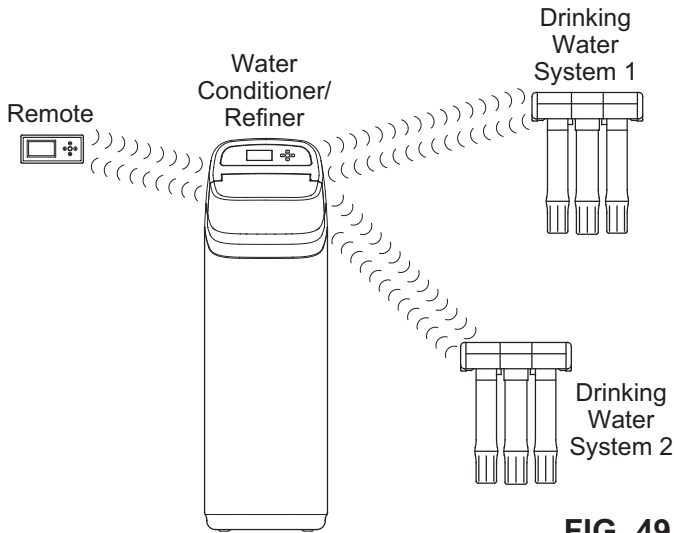
4. When the remote detects a signal from the device, the display will change to show that it has been added to the remote (See Figure 48). If another message appears instead, indicating the device was not added successfully, press the LEFT (◀) button to return to the screen in Figure 46. Repeat Step 3. If this does not work, contact your dealer for service.



**FIG. 48**

5. To exit this screen, press the LEFT (◀) button or wait 30 seconds for it to exit automatically.





**FIG. 49**

**HYDROLINK® REMOTE**

The EcoWater Systems HydroLink® remote is part of a wireless system which monitors multiple water treatment devices in a home. These water treatment devices include water conditioner/refiner(s) and drinking water filter(s) equipped to communicate with this type of system (See Figure 49). The remote displays, in a convenient, central location, useful operating information.

Once devices capable of communicating with the system have been added to the remote (See “Adding a Device” on Page 20), the remote’s normal operating mode displays a sequence of screens showing the status of each device in the system (See Figure 50), and any active alerts, such as “Low salt.”

In addition to monitoring water treatment devices, the remote can also control some water conditioner/refiner operations, such as initiating a manual recharge.

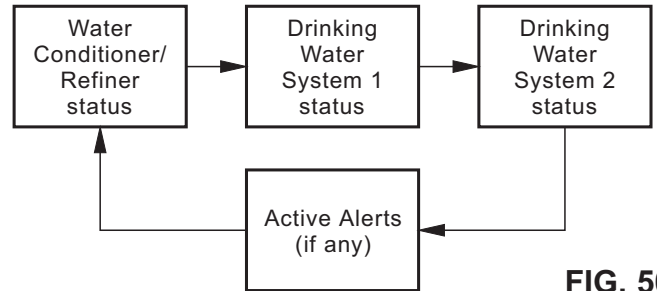
**HYDROLINK® COMMUNICATION SYSTEM**

The devices in the system exchange information in a loosely coupled network. AC powered devices, such as conditioner/refiners, listen for new data all the time and act as data hubs. Battery powered devices like the remote check for information at regular intervals. Battery powered devices like drinking water systems do not communicate directly with each other or the remote, but pass along information through AC powered devices. Up to 4 devices may be added to one remote, including no more than 3 AC powered devices. An AC powered device with a transmitter must be part of any network (usually a water conditioner/refiner).

It is not necessary for every device in a network to be in radio range of all others. Information one device communicates to any other device will be passed along (like gossip) to all devices in the network.

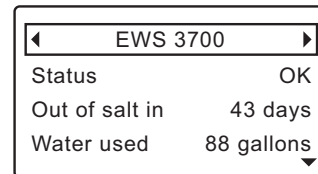
**NAVIGATING THE SCREENS**

When the remote is powered up (by installing the batteries), a logo will briefly appear in the display. Once a device has been added, as shown in the procedure on Page 19, the display will automatically cycle between screens showing the status of water treatment devices communicating with the remote. To manually go to the next screen in the sequence, press the LEFT (◀) or RIGHT (▶) buttons.



**FIG. 50**

Some screens have more information than can be shown at one time (for example, the conditioner/refiner status display shown in Figure 51). A down arrow (▼) in the lower right corner indicates that there is more information below. Use the DOWN (▼) button to scroll through the additional lines.



**FIG. 51**

**ACTIVE ALERTS**

The status screens described above will not be displayed in a rolling sequence when one of the following active alert messages is displayed:

- **Low salt** (See Page 42)
- **Time lost** (Set the conditioner/refiner’s clock, as described on Page 32)
- **Service overdue** (See Page 40)
- **Error code** (Contact your dealer for service)

**MANUALLY REFRESHING THE DATA**

If there has been no button activity for 30 seconds, pressing any button will refresh the data being displayed. Normally each data element refreshes at a much slower rate to conserve battery life.

## CHECKING RF SIGNAL STRENGTH

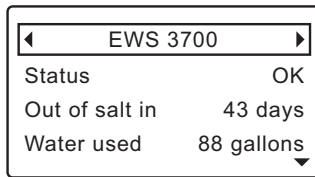
During installation of a system, it is useful to check the strength of the signal from a water treatment device. If you check the signal strength of a device communicating with the remote indirectly through another device, the display will show the strength of the “weakest link” in the chain of communication to the remote.

Begin by checking the signal strength between the conditioner/refiner and the remote. If the signal is weak (2 bars or less on the display shown in Figure 54), move the remote to a different location to try improving the signal strength.

When adding additional devices, such as battery-operated drinking water systems (RO), keep in mind that the signal strength display shows the “weakest link” in the chain of communications. If the link between the RO and the conditioner/refiner is weak, move the RO (if possible) to a location closer to the conditioner/refiner or remove metal objects between the two.

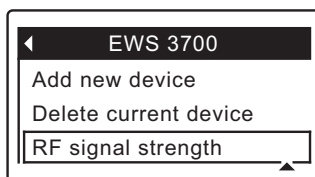
To check the signal strength for a particular device:

1. Press the remote’s LEFT (◀) or RIGHT (▶) buttons to manually advance to the status screen for the device you want to check. The device name will show in the header. (See Figure 52).



**FIG. 52**

2. Press the remote’s SELECT (○) button to display the device menu.
3. Press the DOWN (▼) button to scroll through the menu options until **RF signal strength** is highlighted in a box (See Figure 53).



**FIG. 53**

4. Press the SELECT (○) button, and the screen shown in Figure 54 will appear. The more bars that are filled in black, the stronger the signal. The signal strength display updates every 15 seconds.



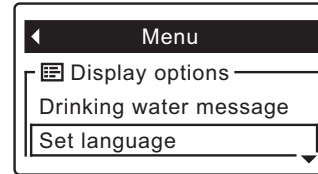
**FIG. 54**

5. To exit this screen, press the LEFT (◀) button.

## SETTING THE LANGUAGE

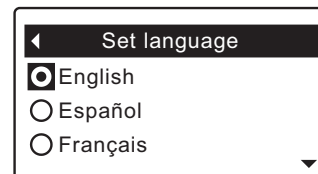
Language is set independently on the remote and conditioner/refiner (See Page 34 to set the conditioner/refiner’s language). Fewer languages are available on the remote. To change the remote’s language:

1. Press the remote’s SELECT (○) button to display a **Menu** screen.
2. Press the DOWN (▼) button to scroll through the menu options until **Set language** is highlighted in a box (See Figure 55). Press the SELECT (○) button.



**FIG. 55**

3. Depending on which devices are added, you could see a message saying “This will delete all devices! Continue?” If so, you would need to add the devices again after changing the language. Press the RIGHT (▶) button to continue (or skip to Step 4 if this message is not displayed).
4. The Set language menu is displayed (See Figure 56). The current language has a dot next to it.

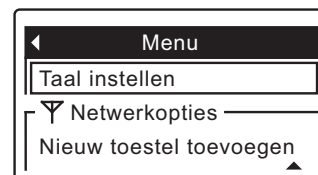


**FIG. 56**

5. Press the DOWN (▼) or UP (▲) buttons to scroll through the list to the desired language, then press SELECT (○) to choose it.
6. Press the SELECT (○) button. The display will go back to the menu shown in Figure 55, in the newly set language.
7. To exit this menu, press the LEFT (◀) button or wait 30 seconds for it to exit automatically.

### TO SET THE REMOTE TO ENGLISH IF ANOTHER LANGUAGE IS DISPLAYED:

From the rolling status screens, press SELECT (○). Press DOWN (▼) to scroll through the list until the line immediately **above** the antenna (Υ) symbol is highlighted (See Figure 57), then press SELECT (○). Press UP (▲) to scroll to **English** at the top of the list, then press SELECT (○) twice. Press LEFT (◀) to exit the menu.



**FIG. 57**

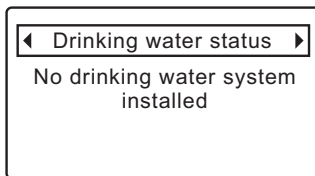


**DRINKING WATER STATUS MESSAGE**

If a communications-capable drinking water filtration (RO) system has been added to the remote, it will have its own status screen displayed during normal operation. Otherwise, a drinking water status screen will display a message like the one shown in Figure 58.

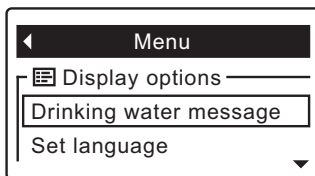
If the message displayed is not appropriate to your system, change it as follows:

1. Press the remote's LEFT (◀) or RIGHT (▶) buttons to manually advance to the **Drinking water status** screen (See Figure 58).



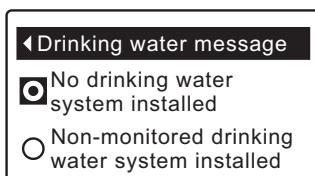
**FIG. 58**

2. Press the remote's SELECT (○) button to display the drinking water status menu (See Figure 59).
3. If necessary, press the DOWN (▼) button to scroll through the menu options until **Drinking water message** is highlighted in a box (See Figure 59).



**FIG. 59**

4. Press the SELECT (○) button to display the Drinking water message menu (See Figure 60).



**FIG. 60**

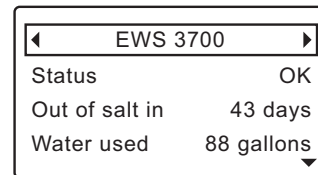
5. The current message has a dot next to it. Press the DOWN (▼) or UP (▲) buttons to scroll between the two messages, then press SELECT (○) to choose one.
6. Press the SELECT (○) button. The display will go back to the menu shown in Figure 59.
7. Press the LEFT (◀) button to exit this menu, or wait 30 seconds for it to exit automatically.

\* The conditioner/refiner may not respond instantly to the remote's command. Because of the way information is distributed in the HydroLink® network, it may take a few seconds (or even minutes if multiple AC powered devices are in the network).

**RECHARGING THE CONDITIONER/REFINER**

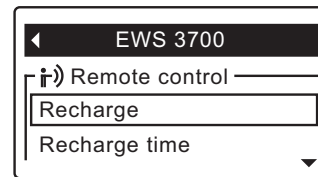
This feature may be used to assure an adequate supply of conditioned water at times of unusually high water use. For example, if you have guests and the "Capacity remaining" line on the conditioner/refiner status screen is at or below 50%, you could deplete conditioned water capacity before the next automatic recharge. Initiating a manual recharge will restore 100% conditioned water capacity after complete.

1. Press the remote's LEFT (◀) or RIGHT (▶) buttons to manually advance to the **EWS 3700** status screen (See Figure 61).



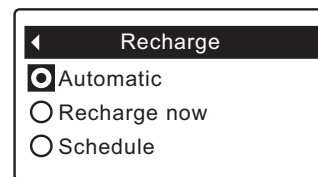
**FIG. 61**

2. Press the remote's SELECT (○) button to display the device menu (See Figure 62).
3. If necessary, press the DOWN (▼) button to scroll through the menu options until **Recharge** is highlighted in a box (See Figure 62).



**FIG. 62**

4. Press the SELECT (○) button to display the Recharge menu (See Figure 63).



**FIG. 63**

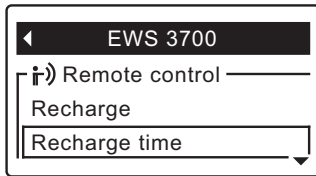
5. The currently selected option has a dot next to it. Press the DOWN (▼) or UP (▲) buttons to scroll to the desired option, then press SELECT (○) to choose it.
  - **Automatic** cancels a manually scheduled recharge (if it has not already begun) and lets the electronic control determine when to recharge next.
  - **Recharge now** begins a recharge after the SELECT (○) button is pushed again in Step 6.\*
  - **Schedule** sets a recharge to begin at the preset recharge time (set according to the instructions at right).
6. Press the SELECT (○) button. The display will go back to the conditioner/refiner menu (Figure 62).
7. Press the LEFT (◀) button to exit this menu, or wait 30 seconds for it to exit automatically.

**SETTING CONDITIONER/REFINER RECHARGE TIME**

When the conditioner/refiner’s electronic control is first powered up, the default time for starting an automatic recharge is 2:00 a.m. This is a good time in most households because water is not being used.

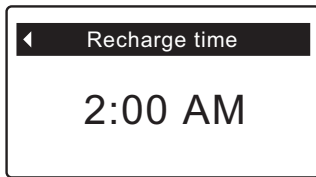
To change the conditioner/refiner’s recharge time using the remote:

1. Press the remote’s LEFT (◀) or RIGHT (▶) buttons to manually advance to the **EWS 3700** status screen (See Figure 61).
2. Press the remote’s SELECT (○) button to display the device menu (See Figure 62).
3. Press the DOWN (▼) button to scroll through the menu options until **Recharge time** is highlighted in a box (See Figure 64).



**FIG. 64**

4. Press the SELECT (○) button to display the Recharge time screen (See Figure 65).



**FIG. 65**

5. Press the UP (▲) or DOWN (▼) buttons to change the recharge time in 1 hour increments. Hold the button down to rapidly advance. Be sure that AM or PM is correct (unless conditioner/refiner is set for a 24-hour clock).
6. Press the SELECT (○) button. The display will go back to the conditioner/refiner menu (Figure 62).
7. Press the LEFT (◀) button to exit this menu, or wait 30 seconds for it to exit automatically.

**CHANGING WHICH DATA ITEMS ARE DISPLAYED IN THE STATUS SCREENS**

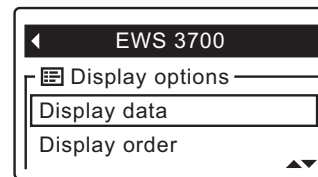
Each device added to the remote (conditioner/refiner, drinking water system, etc.) has a status screen which the remote displays during normal operation. The status screen may be customized by turning items on or off.

On the remote, the conditioner/refiner’s status screen, for example, will include a **Status** line and may also include any or all of the optional data items in the list below. The frequency with which data is updated on the remote depends on the data item:

<u>DATA ITEM</u>	<u>REMOTE DISPLAY UPDATED EVERY</u>
● Out of salt in (days) . . . . .	7 hours
● Soft water left (gallons) . . . . .	10 min.
● Soft water left (liters) . . . . .	10 min.
● Average daily use (gallons) . . . . .	7 hours
● Average daily use (liters) . . . . .	7 hours
● Total minerals removed (lbs) . . . . .	7 hours
● Total minerals removed (kg) . . . . .	7 hours
● Capacity remaining (%) . . . . .	10 min.
● Salt level . . . . .	10 min.
● Total soft water (gallons) . . . . .	10 min.
● Total soft water (m <sup>3</sup> ) . . . . .	10 min.
● Water used today (gallons) . . . . .	10 min.
● Water used today (liters) . . . . .	10 min.

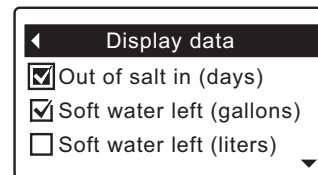
To turn data items on or off:

1. Press the remote’s LEFT (◀) or RIGHT (▶) buttons to manually advance to the status screen you want to customize. For example, to change the data for the conditioner/refiner, manually advance to the **EWS 3700** status screen.
2. Press the remote’s SELECT (○) button to display the device menu.
3. Press the DOWN (▼) button to scroll through the menu options until **Display data** is highlighted in a box (See Figure 66).



**FIG. 66**

4. Press the SELECT (○) button to display the Display data screen (See Figure 67).



**FIG. 67**

5. Press the DOWN (▼) or UP (▲) buttons to scroll through the list of display data items. Items with a check mark in the box next to them will be displayed during normal operation.
6. To select an unchecked display data item, make sure the box next to the item's name is highlighted (box is black inside). Then press the SELECT (○) button. The check mark will appear in the box.
7. To un-select a checked display data item, make sure the box next to the item's name is highlighted (box is black inside). Then press the SELECT (○) button. The check mark will disappear.
8. When selections are complete, exit this menu by pressing the LEFT (◀) button. The display will go back to the device menu (Figure 66).
9. Press the LEFT (◀) button to exit this menu, or wait 30 seconds for it to exit automatically.

## OUT OF SALT IN (X) DAYS

This display, on both the conditioner/refiner and remote status screens, is an **estimate** of the number of days until the conditioner/refiner will be out of salt. This estimate is based on salt level in the brine tank, salt dose used, and average daily water use. It is recalculated when the conditioner/refiner regenerates, and the number of days may decrease, remain the same or even increase at regeneration time (a drop in water use could cause the estimated days left to increase). Between regenerations it will count down.

## PHOTO CELL

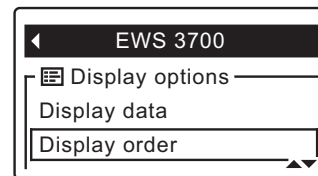
To prolong battery life, the remote has a photo cell above the display (See Figure 44). This cell triggers the display to "go to sleep" (turn off) when the ambient light level stays low for 10 minutes. The display will immediately turn back on when the ambient light level is increased.

**NOTE:** The "Alert" LED (See Figure 44) will not "go to sleep" if ambient light levels are low.

## CHANGING THE ORDER OF DATA ITEMS DISPLAYED IN THE STATUS SCREENS

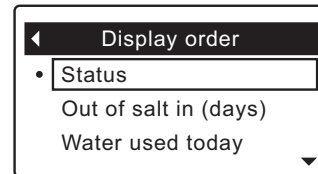
In addition to changing which data items the remote displays during normal operation, the order of these items may be customized, as follows:

1. Press the remote's LEFT (◀) or RIGHT (▶) buttons to manually advance to the status screen you want to customize. For example, to change the order of the conditioner/refiner's screen, manually advance to the **EWS 3700** status screen.
2. Press the remote's SELECT (○) button to display the device menu.
3. Press the DOWN (▼) button to scroll through the menu options until **Display order** is highlighted in a box (See Figure 68).



**FIG. 68**

4. Press the SELECT (○) button to display the Display order screen (See Figure 69).



**FIG. 69**

5. Press the DOWN (▼) or UP (▲) buttons to scroll through the list of display data items. Stop when the item you want to move is highlighted in a box.
6. Press the SELECT (○) button. Arrows will appear next to the item (See Figure 70).



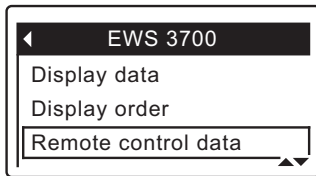
**FIG. 70**

7. Press the UP (▲) or DOWN (▼) buttons to move the item higher or lower in the list.
8. When the item is where you want it in the list, press the SELECT (○) button. The arrows next to the item will disappear.
9. To move another item, return to Step 5. When finished moving items, press the LEFT (◀) button. The display will go back to the device menu (Figure 68).

**CHANGING WHICH DATA ITEMS MAY BE REMOTELY CONTROLLED**

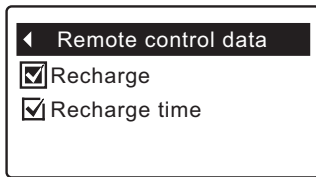
Some devices (conditioner/refiners, for example) have a list of data items which may be controlled by the remote. Remote control items may be customized, as follows:

1. Press the remote's LEFT (◀) or RIGHT (▶) buttons to manually advance to the status screen of the device you want to customize. For example, to change the data for the conditioner/refiner, manually advance to the **EWS 3700** status screen.
2. Press the remote's SELECT (○) button to display the device menu.
3. Press the DOWN (▼) button to scroll through the menu options until **Remote control data** is highlighted in a box (See Figure 71).



**FIG. 71**

4. Press the SELECT (○) button to display the Remote control data screen (See Figure 72).



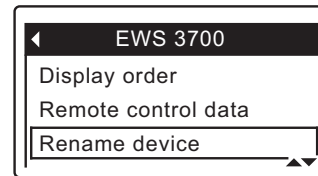
**FIG. 72**

5. Press the DOWN (▼) or UP (▲) buttons to scroll through the list of remote control items. Items with a check mark in the box next to them will be controllable using the remote.
6. To select an unchecked remote control item, make sure the box next to the item's name is highlighted (box is black inside). Then press the SELECT (○) button. The check mark will appear in the box.
7. To un-select a checked remote control item, make sure the box next to the item's name is highlighted (box is black inside). Then press the SELECT (○) button. The check mark will disappear.
8. When selections are complete, exit this menu by pressing the LEFT (◀) button. The display will go back to the device menu (Figure 71).
9. Press the LEFT (◀) button to exit this menu, or wait 30 seconds for it to exit automatically.

**RENAMING A DEVICE**

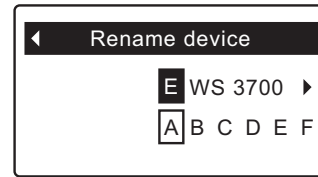
Each device (conditioner/refiner, drinking water system, etc.) in the system has a default name in the header of its status screen. The name may be customized (up to 20 characters long), as follows:

1. Press the remote's LEFT (◀) or RIGHT (▶) buttons to manually advance to the status screen of the device you want to rename. For example, to rename the conditioner/refiner, manually advance to the **EWS 3700** status screen.
2. Press the remote's SELECT (○) button to display the device menu.
3. Press the DOWN (▼) button to scroll through the menu options until **Rename device** is highlighted in a box (See Figure 73).



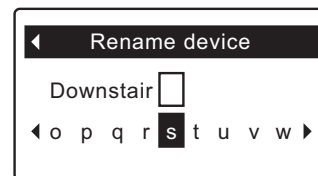
**FIG. 73**

4. Press the SELECT (○) button to display the Rename device screen (See Figure 74).



**FIG. 74**

5. Two lines are displayed below the header. The upper line shows the device name. The lower line is the list of available characters (upper and lower case alphabets, space character, numbers and common punctuation marks). Use the RIGHT (▶) or LEFT (◀) buttons to highlight the first character you want to replace in the old device name.
6. Press DOWN (▼) to switch to the lower line.
7. Press the RIGHT (▶) or LEFT (◀) buttons to scroll through the character list. Stop when the character you want to select is highlighted (See Fig. 75).



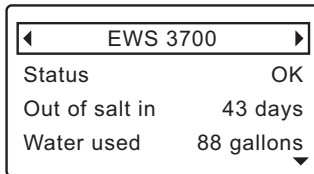
**FIG. 75**

8. Press the SELECT (○) button. The character you picked is added to the upper line.
9. To select the next character, return to Step 7. When finished entering the device name, press the UP (▲) button to switch to the upper line, then press SELECT (○) to go back to the device menu (Figure 73).

## DELETING A DEVICE

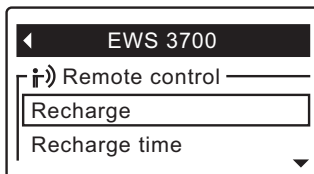
To delete a device from the remote (possible reasons for deleting a device include replacing or upgrading the conditioner/refiner's electronic control):

1. Press the remote's LEFT (◀) or RIGHT (▶) buttons to manually advance to the status screen for the device to delete. The device name will show in the header. (See Figure 76).



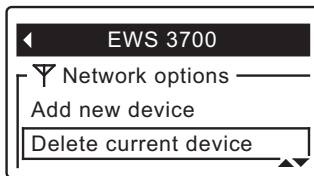
**FIG. 76**

2. Press the remote's SELECT (O) button to display the device menu (See Figure 77).



**FIG. 77**

3. Press the DOWN (▼) button to scroll through the menu options until **Delete current device** is highlighted in a box (See Figure 78).



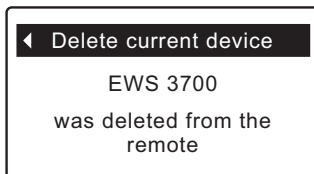
**FIG. 78**

4. Press the SELECT (O) button. The screen shown in Figure 79 will appear.



**FIG. 79**

5. Press the RIGHT (▶) button. The screen shown in Figure 80 will appear.



**FIG. 80**

6. To exit this screen, press the LEFT (◀) button or wait 30 seconds for it to exit automatically.

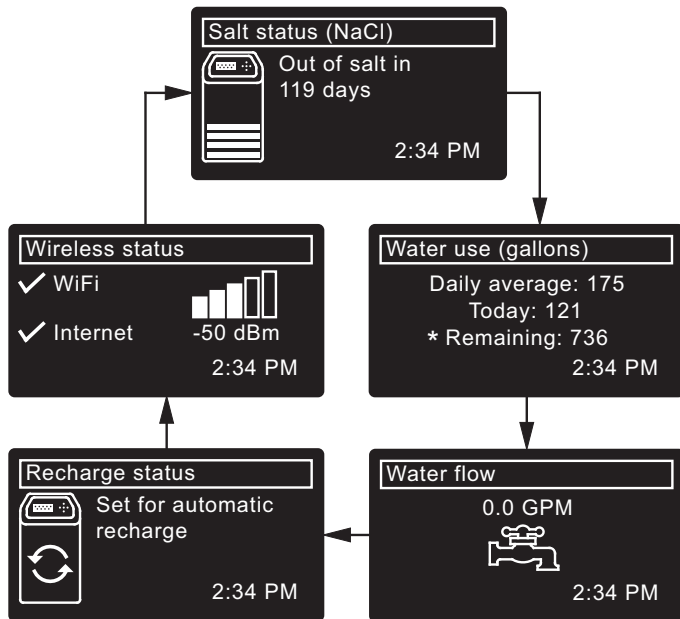
**NORMAL OPERATION**

**CONDITIONER/REFINER STATUS SCREENS**

During normal operation, the EcoWater Systems conditioner/refiner's display shows up to five status screens. Page 34 explains how individual screens can be turned on or off. Each is shown for six seconds, in a rolling sequence (See Figure 81).

The "Wireless status" screen will only be shown on Wi-Fi systems. The check marks indicate the following:

- ✓ **WiFi** - The softener is connected to a Wi-Fi router.
- ✓ **Internet** - The softener is connected to a Wi-Fi router which is connected to the internet.



\*Water remaining before the next recharge. **FIG. 79**

Pressing the conditioner/refiner's RIGHT (▶) button manually advances to the next screen in the sequence. Pressing the LEFT (◀) button manually returns to the previous status screen. If no buttons are pressed for 30 seconds, the automatic rolling sequence resumes.

**OTHER MESSAGES, ALERTS & REMINDERS**

The conditioner/refiner status screens described in the previous section will not be displayed in a rolling sequence when one of the following items is displayed:

- **Recharge status** (Displayed during recharges, showing valve position and time remaining)
- **Add salt or Out of salt** (See Page 42)
- **Current time** setting screen instead of status screens indicates time has been lost, perhaps after a long power loss. Set the time (See Page 32).
- **Service reminder** (See Page 40)
- **Error detected** (Contact your dealer for service)

**FLASHING DISPLAY**

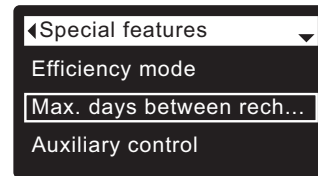
The conditioner/refiner's display will flash on and off when one or more of the following conditions occurs:

- Salt needs to be added
- Time needs to be set (Time has been lost)
- Service is overdue (Service reminder)
- Error condition

The flashing will stop after any key is pressed. However, it will start again at Midnight if the underlying condition (e.g. low salt level) has not been addressed.

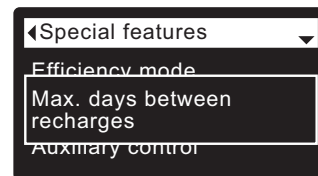
**LONG DISPLAY SCREEN MESSAGES**

Most messages in the conditioner/refiner's display screens are short enough to be shown as a single line. Longer messages will be truncated (See Figure 82 for an example) until you highlight them.



**FIG. 82**

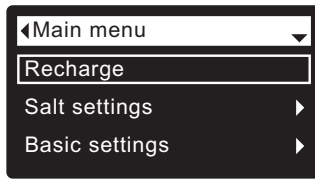
One second after being highlighted, the viewing box expands (See Figure 83) to show the entire message. After three seconds the view resets (Figure 82).



**FIG. 83**



**MAIN MENU**



**FIG. 84**

During normal operation (status screens rolling), press the conditioner/refiner’s SELECT (O) button to display the Main menu (See Figure 84). This menu and its subsidiary screens are used to control these operations:

- **Recharge** (See Page 32)
- **Salt settings**
  - Salt level<sup>①</sup> (See Page 31)
  - Low salt alarm (See Page 31)
  - Salt type (See Page 31)
- **Basic settings**
  - Current time (See Page 32)
  - Hardness (See Page 33)
  - Iron level (See Page 33)
  - Recharge time (See Page 33)
  - Rolling screens (See Page 34)
- **User preferences**
  - Language (See Page 34)
  - Time format (See Page 35)
  - Volume units (See Page 35)
  - Hardness units (See Page 35)
  - Weight units (See Page 35)
- **System information**
  - Model information (See Page 36)
  - Wireless information (See Page 36)
  - Water available (See Page 36)
  - Daily avg. water used (See Page 36)
  - Water used today (See Page 36)
  - Total water used (See Page 36)
  - Current water flow (See Page 36)
  - Days powered up (See Page 36)
  - Last recharge (See Page 36)
  - Total recharges (See Page 36)
- **Advanced settings**
  - **Cycle times**
    - Backwash time (See Page 37)
    - 2nd backwash (On/Off) (See Page 37)
    - 2nd backwash time (See Page 37)
    - Fast rinse time (See Page 37)
  - **Special features**
    - Efficiency mode (See Page 38)
    - Max. days between recharges (See Page 38)
    - Auxiliary control (See Page 39)
    - Chemical feed volume<sup>②</sup> (See Page 39)
    - Chemical feed timer<sup>②</sup> (See Page 39)
    - 97% feature (See Page 38)
    - Water to drain sensor<sup>③</sup> (See Page 40)
    - Service reminder (See Page 40)
  - **Troubleshooting**
    - Diagnostics (See Page 41)
    - Setup changes (See Page 41)
    - SLS calibration<sup>④</sup> (See Page 41)
  - **Wireless setup** (See Pages 13-15) on Wi-Fi systems OR **Connect to remote** (See Page 19)

① Only on two-tank models without a salt level sensor.  
 ② Only displayed if Auxiliary control is set to Chemical feed.  
 ③ Only on Wi-Fi systems.  
 ④ Only on cabinet models with a salt level sensor.



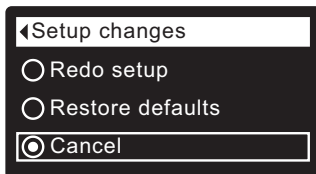
**LOCKOUT FEATURE**

A “lockout” feature is available to prevent user modification of parameters that affect conditioner/refiner performance. The unit is shipped from the factory with the lockout feature off. After programming is complete, the lockout feature can be turned on to prevent changes to the following:

- **Hardness**
- **Iron level**
- **Backwash time**
- **Second backwash (On/Off)**
- **Second backwash time**
- **Fast rinse time**
- **Efficiency mode**
- **Max days between recharges**
- **Auxiliary control**
- **Chemical feed volume**
- **Chemical feed timer**
- **97% feature**
- **Water to drain sensor**
- **Service reminder**
- **Setup changes**
- **SLS calibration point 0**
- **SLS calibration point 1**

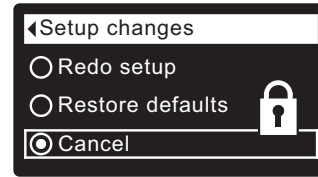
**To turn on the lockout feature:**

1. From any of the rolling status screens, press the SELECT (O) button to display the **Main menu**.
2. Press the DOWN (▼) button to scroll through the menu options until **Advanced settings** is highlighted.
3. Press the SELECT (O) button to display the Advanced settings menu.
4. Press the DOWN (▼) button to scroll through the menu options until **Troubleshooting** is highlighted.
5. Press the SELECT (O) button to display the Troubleshooting menu.
6. Press the DOWN (▼) button to scroll through the menu options until **Setup changes** is highlighted.
7. Press the SELECT (O) button to display the Setup changes menu (See Figure 85).



**FIG. 85**

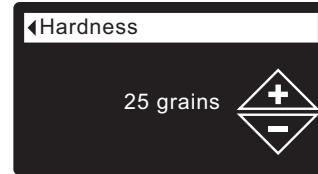
8. Press the RIGHT (▶) button. A flashing padlock icon will appear, as shown in Figure 86.



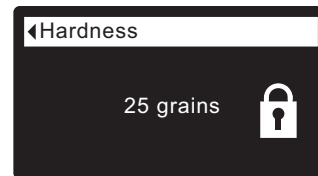
**FIG. 86**

9. Press the SELECT (O) button.
10. Press the LEFT (◀) button three times to return to the rolling status screens.

When the lockout feature is on, the flashing padlock icon will appear in any screen that would normally be used to change a parameter in the list to the left. For example, the **Hardness** screen will look like Figure 88, instead of Figure 87.

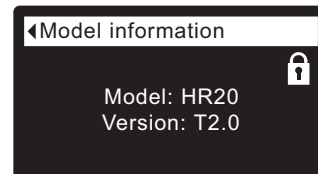


**FIG. 87**



**FIG. 88**

Another indicator that the lockout feature is on is the **Model Information** screen. This screen appears on power-up, and can also be displayed from the System Information menu (See Page 36). If the lockout feature is on, there will be a non-flashing padlock icon in the upper right corner (See Figure 89).



**FIG. 89**

**To turn off the lockout feature:**

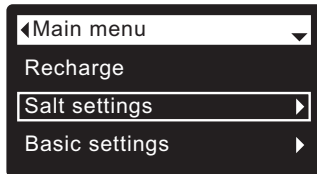
- 1-7. Go to the **Setup changes** screen (Figure 86) by following Steps 1-7 at left.
8. Press the RIGHT (▶) button. The flashing padlock icon will disappear, as shown in Figure 85.
9. Press the SELECT (O) button.
10. Press the LEFT (◀) button three times to return to the rolling status screens.

**MANUALLY SETTING SALT LEVEL  
(Two-Tank Models only)**

This feature is active only on units without a salt level sensor connected to the electronic controller. Cabinet models (no separate brine tank) have an internal sensor that automatically measures the level of salt in the tank. The salt level is displayed on the salt status rolling screen and is used by the electronic control to calculate the number of days before empty (See “Low Salt Alarm” at right).

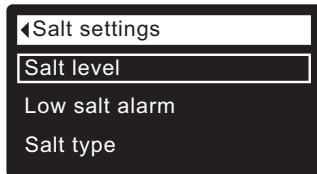
**On two-tank models, you must manually enter the salt level number each time you add salt:**

1. From any of the rolling status screens, press the SELECT (O) button to display the **Main menu**.
2. Press the DOWN (▼) button to scroll through the menu options until **Salt settings** is highlighted (See Figure 90).



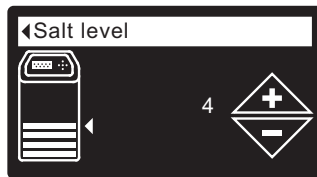
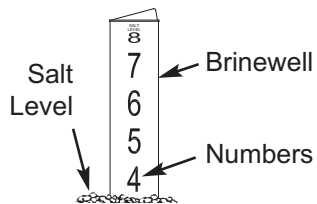
**FIG. 90**

3. Press the SELECT (O) button to display the Salt settings menu (See Figure 91).



**FIG. 91**

4. Make sure **Salt level** is highlighted.
5. Press the SELECT (O) button to display the Salt level screen (See Figure 92). This screen will not automatically exit for 15 minutes.



**FIG. 92**

6. After adding and leveling salt, observe the numbered scale on the brine well (See Figure 92). Press UP (▲) or DOWN (▼) to match the lowest number visible above the salt.
7. Press the SELECT (O) button. The display will go back to the Salt settings menu (Figure 91).
8. Press the LEFT (◀) button twice to return to the rolling status screens. It will also exit automatically if no buttons are pressed for four minutes.

**LOW SALT ALARM**

Use this feature to program when the electronic control will display a low salt alarm. The number of days can be customized, or the feature can be turned off. The default is 20 days.

- 1-3. Go to the **Salt settings** menu by following Steps 1-3 in “Manually Setting Salt Level” at left.
4. Press the DOWN (▼) button to scroll through the menu options until **Low salt alarm** is highlighted.
5. Press the SELECT (O) button to display the Low salt alarm screen (See Figure 93).



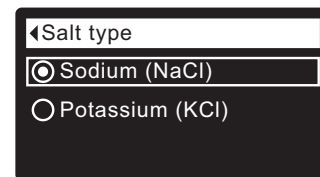
**FIG. 93**

6. Press the UP (▲) or DOWN (▼) buttons to change the number of days. Set the number of days to provide enough time to purchase salt and avoid running into hard water. Setting the number of days below 1 turns the alarm feature off.
7. Press the SELECT (O) button. The display will go back to the Salt settings menu.
8. Press the LEFT (◀) button twice to return to the rolling status screens.

**SETTING SALT TYPE**

Use this feature to program the electronic control with which type of salt is used. The default is NaCl. Selecting KCl increases fill time 25% and brine/slow rinse times 12%.

- 1-3. Go to the **Salt settings** menu by following Steps 1-3 in “Manually Setting Salt Level” at left.
4. Press the DOWN (▼) button to scroll through the menu options until **Salt type** is highlighted.
5. Press the SELECT (O) button to display the Salt type menu (See Figure 94).



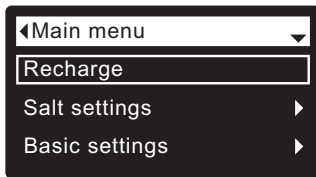
**FIG. 94**

6. If the desired salt type already has a dot next to it (See Figure 94), go to Step 7. Otherwise, press the conditioner/refiner’s DOWN (▼) or UP (▲) buttons to scroll to the other salt type, then press SELECT (O) to choose it.
7. Press the SELECT (O) button. The display will go back to the Salt settings menu.
8. Press the LEFT (◀) button twice to return to the rolling status screens.

**RECHARGING THE CONDITIONER/REFINER**

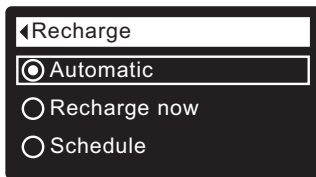
This feature may be used to assure an adequate supply of conditioned water at times of unusually high water use. For example, if you have guests and the “Water available” screen (See Page 36) is at or below 50%, you could deplete conditioned water capacity before the next automatic recharge. Initiating a manual recharge will restore 100% conditioned water capacity after complete.

1. From any of the rolling status screens, press the SELECT (O) button to display the **Main menu**.



**FIG. 95**

2. Make sure **Recharge** is highlighted (See Figure 95).
3. Press the SELECT (O) button to display the Recharge menu (See Figure 96).



**FIG. 96**

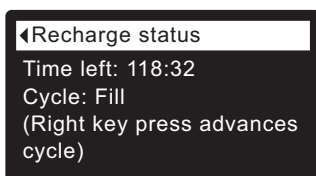
4. If the desired option already has a dot next to it (See Figure 96), go to Step 5. Otherwise, press the DOWN (▼) or UP (▲) buttons to scroll to the desired option, then press SELECT (O) to choose it.

- **Automatic** cancels a manually scheduled recharge (if it has not already begun) and lets the electronic control determine when to recharge next.

- **Recharge now** begins a recharge immediately after the SELECT (O) button is pushed again in Step 5.

- **Schedule** sets a recharge to begin at the preset recharge time (set according to the instructions on Page 33).

5. Press the SELECT (O) button. If **Recharge now** is selected, the display immediately goes to the Recharge status screen (See Figure 97). If **Automatic** or **Schedule** are selected, the display goes back to the Main menu (Figure 95).



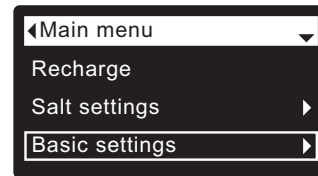
**FIG. 97**

6. Press the LEFT (◀) button (twice from the Recharge status screen) to return to the rolling status screens.

**SETTING THE CURRENT TIME**

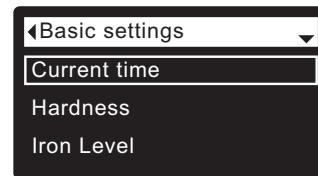
When the conditioner/refiner’s electronic control is first powered up, a “wizard” screen prompts you to set the current time (See Pages 13-15 or 17). To change the time at a later date, such as after a long power loss:

1. From any of the rolling status screens, press the SELECT (O) button to display the **Main menu**.
2. Press the DOWN (▼) button to scroll through the menu options until **Basic settings** is highlighted (See Figure 98).



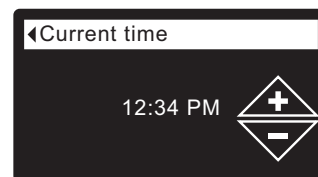
**FIG. 98**

3. Press the SELECT (O) button to display the Basic settings menu (See Figure 99).



**FIG. 99**

4. Make sure **Current time** is highlighted.
5. Press the SELECT (O) button to display the Current time screen (See Figure 100).



**FIG. 100**

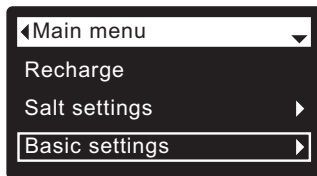
6. Press the UP (▲) or DOWN (▼) buttons to change the time. Hold the button down to rapidly advance. Be sure that AM or PM is correct (unless conditioner/refiner is set for a 24-hour clock).
7. Press the SELECT (O) button. The display will go back to the Basic settings menu (Figure 99).
8. Press the LEFT (◀) button twice to return to the rolling status screens.

**NOTE:** On Wi-Fi connected systems, the current time will be updated and maintained automatically via Wi-Fi.

## SETTING RECHARGE TIME

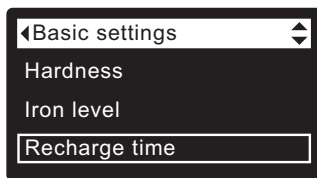
When the conditioner/refiner's electronic control is first powered up, the default time for starting an automatic recharge is 2:00 a.m. This is a good time in most households because water is not being used. To change this time:

1. From any of the rolling status screens, press the SELECT (O) button to display the **Main menu**.
2. Press the DOWN (▼) button to scroll through the menu options until **Basic settings** is highlighted (See Figure 101).



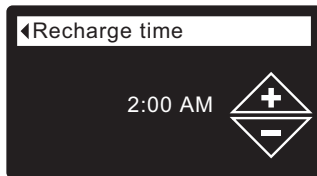
**FIG. 101**

3. Press the SELECT (O) button to display the Basic settings menu (See Figure 102).



**FIG. 102**

4. Press the DOWN (▼) button to scroll through the menu options until **Recharge time** is highlighted.
5. Press the SELECT (O) button to display the Recharge time screen (See Figure 103).



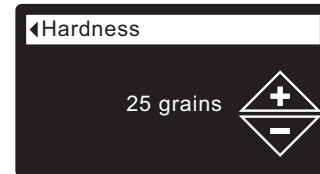
**FIG. 103**

6. Press the UP (▲) or DOWN (▼) buttons to change the recharge time in 1 hour increments. Hold the button down to rapidly advance. Be sure that AM or PM is correct (unless conditioner/refiner is set for a 24-hour clock).
7. Press the SELECT (O) button. The display will go back to the Basic settings menu (Figure 102).
8. Press the LEFT (◀) button twice to return to the rolling status screens.

## SETTING HARDNESS

When the conditioner/refiner's electronic control is first powered up, a "wizard" screen prompts you to enter your water's hardness (See Pages 13-15 or 17). To change it:

- 1-3. Go to the **Basic settings** menu by following Steps 1-3 in "Setting Recharge Time" at left.
4. Press the DOWN (▼) button to scroll through the menu options until **Hardness** is highlighted.
5. Press the SELECT (O) button to display the Hardness screen (See Figure 104).



**FIG. 104**

6. Press the UP (▲) or DOWN (▼) buttons to set the value for your water's hardness. Hold the button down to rapidly advance.

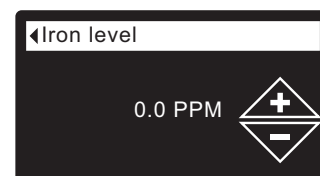
**NOTE:** Do not increase the hardness setting to compensate for iron in your water. The electronic control compensates automatically after you set the iron level, below.

7. Press the SELECT (O) button. The display will go back to the Basic settings menu.
8. Press the LEFT (◀) button twice to return to the rolling status screens.

## SETTING IRON LEVEL

When the conditioner/refiner's electronic control is first powered up, a "wizard" screen prompts you to enter your water's iron level (See Pages 13-15 or 17). The conversion is 3 grains per ppm of clear water iron. To change:

- 1-3. Go to the **Basic settings** menu by following Steps 1-3 in "Setting Recharge Time" at left.
4. Press the DOWN (▼) button to scroll through the menu options until **Iron level** is highlighted.
5. Press the SELECT (O) button to display the Iron level screen (See Figure 105).



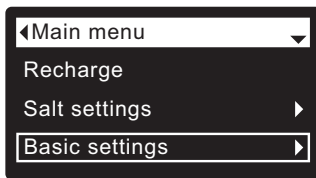
**FIG. 105**

6. Press the UP (▲) or DOWN (▼) buttons to set the value for iron in your water. Hold the button down to rapidly advance.
7. Press the SELECT (O) button. The display will go back to the Basic settings menu.
8. Press the LEFT (◀) button twice to return to the rolling status screens.

**MODIFYING ROLLING SCREENS**

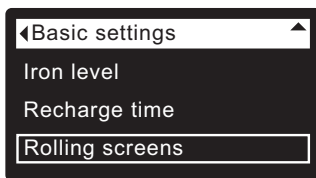
During normal conditioner/refiner operation, up to five status screens are shown in sequence (See “Conditioner/Refiner Status Screens” on Page 28). When the conditioner/refiner’s electronic control is first powered up, the default is to show all four. You can turn on/off individual screens\*:

1. From any of the rolling status screens, press the SELECT (O) button to display the **Main menu**.
2. Press the DOWN (▼) button to scroll through the menu options until **Basic settings** is highlighted (See Figure 106).



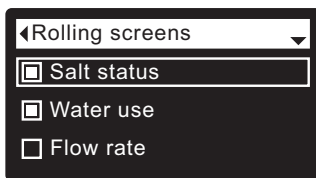
**FIG. 106**

3. Press the SELECT (O) button to display the Basic settings menu (See Figure 107).



**FIG. 107**

4. Press the DOWN (▼) button to scroll through the menu options until **Rolling screens** is highlighted.
5. Press the SELECT (O) button to display the Rolling screens menu (See Figure 108).



**FIG. 108**

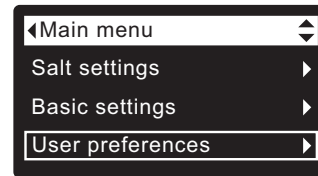
6. Press the DOWN (▼) or UP (▲) buttons to scroll through the list. Items with a black square next to them will be displayed during normal operation.
7. To un-select a screen, make sure its name is highlighted in a box. Then press the SELECT (O) button. The black square will disappear. Pressing SELECT (O) again makes the black square reappear and re-selects the highlighted item. At least one screen must be selected/highlighted.
8. When selections are complete, exit this menu by pressing the LEFT (◀) button. The display will go back to the Basic settings menu (Figure 107).
9. Press the LEFT (◀) button twice to return to the rolling status screens.

\*This does not include service reminders, errors, alerts or Recharge status screens.

**SETTING THE LANGUAGE**

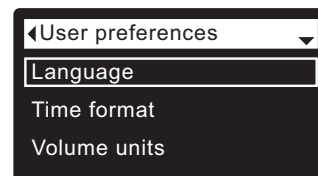
When the conditioner/refiner’s electronic control is first powered up, a “wizard” screen prompts you to set the language (See Page 13-15 or 17). Language is set independently on the conditioner/refiner and remote (See Page 22 to set the remote’s language). To change the conditioner/ refiner’s language:

1. From any of the rolling status screens, press the SELECT (O) button to display the **Main menu**.
2. Press the DOWN (▼) button to scroll through the menu options until **User preferences** is highlighted (See Figure 109).



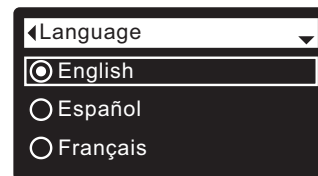
**FIG. 109**

3. Press the SELECT (O) button to display the User preferences menu (See Figure 110).



**FIG. 110**

4. Make sure **Language** is highlighted.
5. Press the SELECT (O) button to display the Language menu (See Figure 111).



**FIG. 111**

6. If the desired language already has a dot next to it (See Figure 111), go to Step 7. Otherwise, press the DOWN (▼) or UP (▲) buttons to scroll to the desired language, then press SELECT (O) to choose it. The choices are: English, Spanish, French, Italian, German, Dutch, Polish, Russian, Hungarian, Turkish, Lithuanian, Greek, Romanian, Czech, Slovak, Bulgarian, Serbian or Croatian.
7. Press the SELECT (O) button. The display will go back to the User preferences menu (Figure 110).
8. Press the LEFT (◀) button twice to return to the rolling status screens.

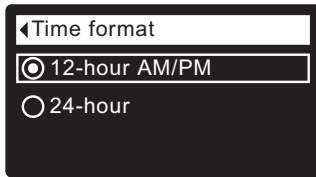
**TO SET THE CONDITIONER/REFINER TO ENGLISH IF ANOTHER LANGUAGE IS DISPLAYED:**  
From the rolling status screens, press SELECT (O). Press DOWN (▼) three times, then press SELECT (O) twice. Press UP (▲) to scroll to **English** at the top of the list, then press SELECT (O) twice. Press LEFT (◀) twice to exit all menus.



## SETTING TIME FORMAT

Use this feature to select a 12-hour (AM/PM) or 24-hour clock.

1. From any of the rolling status screens, press the SELECT (O) button to display the **Main menu**.
2. Press the DOWN (▼) button to scroll through the menu options until **User preferences** is highlighted.
3. Press the SELECT (O) button to display the User preferences menu.
4. Press the DOWN (▼) button to scroll through the menu options until **Time format** is highlighted.
5. Press the SELECT (O) button to display the Time format menu (See Figure 112).



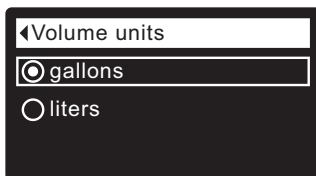
**FIG. 112**

6. If the desired time format already has a dot next to it (See Figure 112), go to Step 7. Otherwise, press the DOWN (▼) or UP (▲) buttons to scroll to the other time format, then press SELECT (O) to choose it.
7. Press the SELECT (O) button. The display will go back to the User preferences menu.
8. Press the LEFT (◀) button twice to return to the rolling status screens.

## SETTING VOLUME UNITS

Use this feature to select gallons or liters as volume units.

- 1-3. Go to the **User preferences** menu by following Steps 1-3 in "Setting Time Format" above.
4. Press the DOWN (▼) button to scroll through the menu options until **Volume units** is highlighted.
5. Press the SELECT (O) button to display the Volume units menu (See Figure 113).



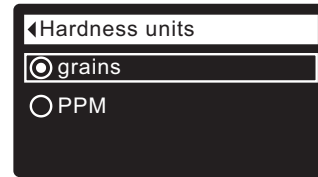
**FIG. 113**

6. If the desired volume unit already has a dot next to it (See Figure 113), go to Step 7. Otherwise, press the DOWN (▼) or UP (▲) buttons to scroll to the other volume unit, then press SELECT (O) to choose it.
7. Press the SELECT (O) button. The display will go back to the User preferences menu.
8. Press the LEFT (◀) button twice to return to the rolling status screens.

## SETTING HARDNESS UNITS

Use this feature to select grains or parts per million (ppm) as hardness units.

1. From any of the rolling status screens, press the SELECT (O) button to display the **Main menu**.
2. Press the DOWN (▼) button to scroll through the menu options until **User preferences** is highlighted.
3. Press the SELECT (O) button to display the User preferences menu.
4. Press the DOWN (▼) button to scroll through the menu options until **Hardness units** is highlighted.
5. Press the SELECT (O) button to display the Hardness units menu (See Figure 114).



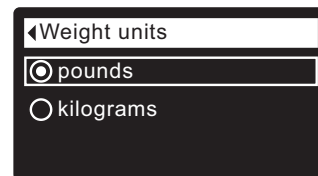
**FIG. 114**

6. If the desired hardness unit already has a dot next to it (See Figure 114), go to Step 7. Otherwise, press the DOWN (▼) or UP (▲) buttons to scroll to the other hardness unit, then press SELECT (O) to choose it.
7. Press the SELECT (O) button. The display will go back to the User preferences menu.
8. Press the LEFT (◀) button twice to return to the rolling status screens.

## SETTING WEIGHT UNITS

Use this feature to select pounds or kilograms as weight units.

- 1-3. Go to the **User preferences** menu by following Steps 1-3 in "Setting Hardness Units" above.
4. Press the DOWN (▼) button to scroll through the menu options until **Weight units** is highlighted.
5. Press the SELECT (O) button to display the Weight units menu (See Figure 115).



**FIG. 115**

6. If the desired weight unit already has a dot next to it (See Figure 115), go to Step 7. Otherwise, press the DOWN (▼) or UP (▲) buttons to scroll to the other weight unit, then press SELECT (O) to choose it.
7. Press the SELECT (O) button. The display will go back to the User preferences menu.
8. Press the LEFT (◀) button twice to return to the rolling status screens.

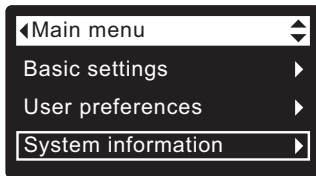
**SYSTEM INFORMATION**

Use these features to look up the following information about the conditioner/refiner and its operations:

- **Model information** (model number and software version)
- **Wireless information** (only on Wi-Fi systems)
- **Water available** (conditioned water ready for use)
- **Daily average water used**
- **Water used today**
- **Total water used** (explained in Step 6, below)
- **Current water flow**
- **Days powered up**
- **Last recharge**
- **Total recharges**

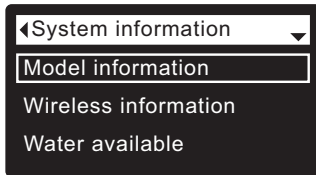
To display one of these screens:

1. From any of the rolling status screens, press the SELECT (O) button to display the **Main menu**.
2. Press the DOWN (▼) button to scroll through the menu options until **System information** is highlighted (See Figure 116).



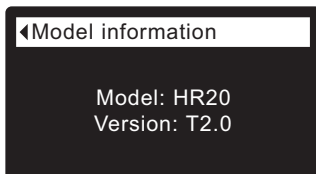
**FIG. 116**

3. Press the SELECT (O) button to display the System information menu (See Figure 117).

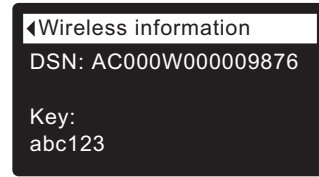


**FIG. 117**

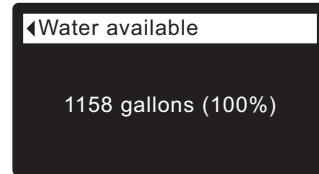
4. Press the DOWN (▼) button to scroll through the menu options until the desired option is highlighted (See list at the top of this column).
5. Press the SELECT (O) button to display the desired information screen (See Figures 118-127).
6. The **Total water used** screen (See Figure 123) shows the volume of water used since it was last reset (it works like the trip odometer in a car). To reset the value to 0, press the RIGHT (▶) button while this screen is displayed.
7. When finished viewing an information screen, press the SELECT (O) button. The display will go back to the System information menu (Figure 117). It will also exit automatically if no buttons are pressed for four minutes.
8. Press the LEFT (◀) button twice to return to the rolling status screens.



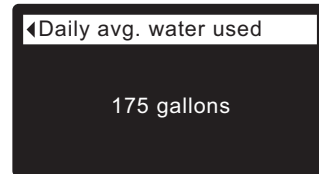
**FIG. 118**



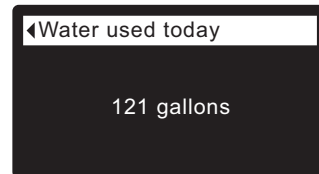
**FIG. 119**



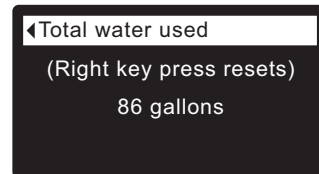
**FIG. 120**



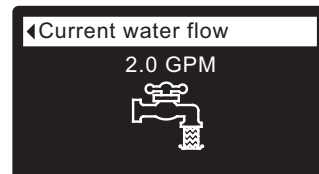
**FIG. 121**



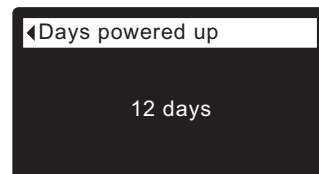
**FIG. 122**



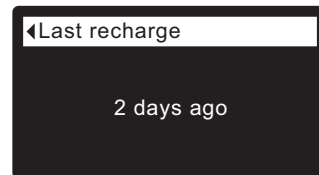
**FIG. 123**



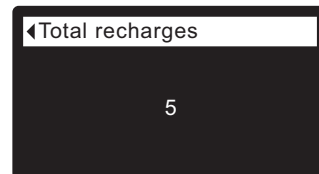
**FIG. 124**



**FIG. 125**



**FIG. 126**



**FIG. 127**



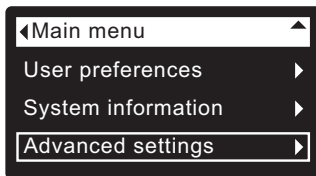
**CYCLE TIMES**

Use these features to change the following conditioner/refiner operations:

- **Backwash time**
- **Second backwash (On/Off)**
- **Second backwash time**
- **Fast rinse time**

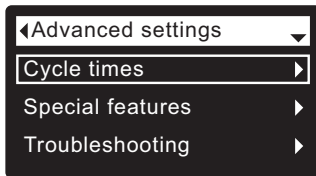
To display these screens:

1. From any of the rolling status screens, press the SELECT (O) button to display the **Main menu**.
2. Press the DOWN (▼) button to scroll through the menu options until **Advanced settings** is highlighted (See Figure 128).



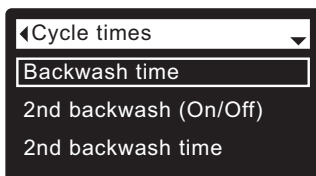
**FIG. 128**

3. Press the SELECT (O) button to display the Advanced settings menu (See Figure 129).



**FIG. 129**

4. Make sure **Cycle times** is highlighted.
5. Press the SELECT (O) button to display the Cycle times menu (See Figure 130).



**FIG. 130**

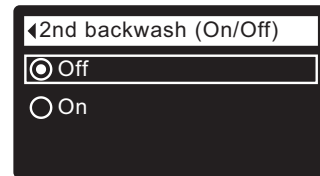
6. Press the DOWN (▼) button to scroll through the menu options until the desired option is highlighted (See list at the top of this column).
7. Press the SELECT (O) button to display the desired cycle time screen (See Figures 131-134).
8. **See the right column on this page for specific instructions on each cycle time screen.**
9. Press the SELECT (O) button. The display will go back to the Cycle times menu (Figure 130).
10. Press the LEFT (◀) button three times to return to the rolling status screens.

- 8a. **Backwash time:** Press the UP (▲) or DOWN (▼) buttons to change the backwash time. Hold the button down to rapidly advance. The backwash time can be set from 1 to 30 minutes\* (See Figure 131).



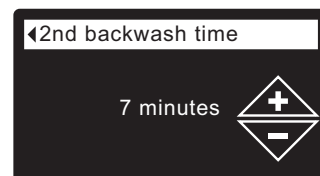
**FIG. 131**

- 8b. **Second backwash (On/Off):** If the desired option already has a dot next to it (See Figure 132), go to Step 9. Otherwise, press the DOWN (▼) or UP (▲) buttons to scroll to the other option, then press SELECT (O) to choose it. Setting this feature On adds a second backwash and rinse at the beginning of the recharge cycle. Default is Off. Set this feature On if your water supply contains a lot of sediment or iron.



**FIG. 132**

- 8c. **Second backwash time:** Press the UP (▲) or DOWN (▼) buttons to change the second backwash time. Hold the button down to rapidly advance. The time can be set from 0 to 30 minutes (See Figure 133).



**FIG. 133**

- 8d. **Fast rinse time:** Press the UP (▲) or DOWN (▼) buttons to change the fast rinse time. Hold the button down to rapidly advance. The fast rinse time can be set from 1 to 30 minutes\* (See Figure 134).



**FIG. 134**

\*Reducing the backwash and fast rinse times below a conditioner/refiner model's default settings can result in salty water after recharges.

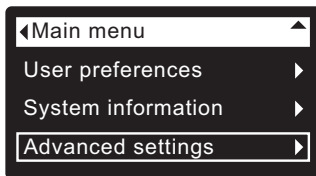
**SPECIAL FEATURES**

Use these features to change the following operations:

- **Efficiency mode**
- **Maximum days between recharges**
- **Auxiliary control** (described on Page 39)
- **Chemical feed volume\*** (described on Page 39)
- **Chemical feed timer\*** (described on Page 39)
- **97% feature**
- **Water to drain sensor** (described on Page 40)
- **Service reminder** (described on Page 40)

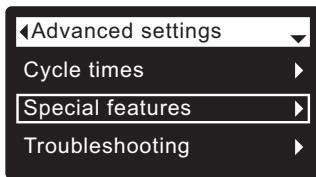
To display one these screens:

1. From any of the rolling status screens, press the SELECT (O) button to display the **Main menu**.
2. Press the DOWN (▼) button to scroll through the menu options until **Advanced settings** is highlighted (See Figure 135).



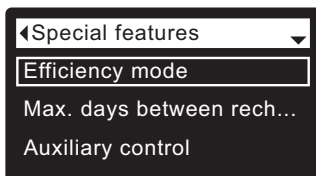
**FIG. 135**

3. Press the SELECT (O) button to display the Advanced settings menu (See Figure 136).



**FIG. 136**

4. Press the DOWN (▼) button to scroll through the menu options until **Special features** is highlighted.
5. Press the SELECT (O) button to display the Special features menu (See Figure 137).



**FIG. 137**

6. Press the DOWN (▼) button to scroll through the menu options until the desired option is highlighted (See list at the top of this column).
7. Press the SELECT (O) button to display the desired special feature screen (See Figures 138-140).
8. **See the right column on this page for specific instructions on each cycle time screen.**
9. Press the SELECT (O) button. The display will go back to the Special features menu (Figure 137).
10. Press the LEFT (◀) button three times to return to the rolling status screens.

\*Only displayed if Auxiliary control is set to Chemical feed.

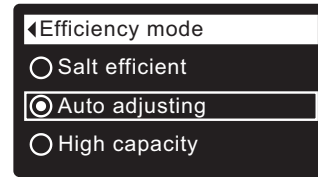
**8a. Efficiency mode:** If the desired efficiency mode already has a dot next to it (See Figure 138), go to Step 9. Otherwise, press the DOWN (▼) or UP (▲) buttons to scroll to the desired efficiency mode, then press SELECT (O) to choose it.

● **Salt efficient** limits available salt doses to maintain 4000 grains/lb. of salt efficiency. Units may recharge more frequently.

● **Auto adjusting** is the default. It automatically adjusts salt doses to target a 3-4 day interval between recharges. Recommended.

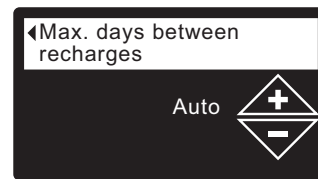
● **High capacity** is for applications where very low "bleed" (less than 1.5 ppm) of hardness can be tolerated. Such applications include water for boilers. This setting will consume higher quantities of salt.

**NOTE:** California regulations require the efficiency mode be set to **Salt efficient** for units installed in the state of California.



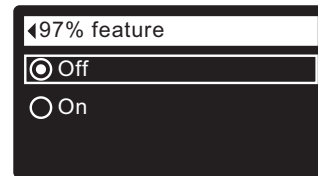
**FIG. 138**

**8b. Maximum days between recharges:** Press the UP (▲) or DOWN (▼) buttons to change the number of days (See Figure 139). The feature can be set from 1 to 15 days. Setting the number of days below 1 turns the feature off and defaults to automatic control of recharging.



**FIG. 139**

**8c. 97% feature:** If the desired option already has a dot next to it (See Figure 140), go to Step 9. Otherwise, press the DOWN (▼) or UP (▲) buttons to scroll to the other option, then press SELECT (O) to choose it. If this feature is On, the conditioner/refiner will automatically recharge when 97% of capacity is used, at any time of day. Default is Off.



**FIG. 140**

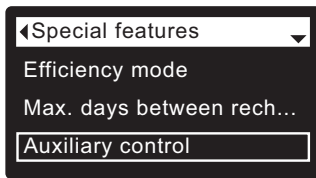
**AUXILIARY CONTROL**

The electronic control has an auxiliary output which can control external devices in a water treatment system. The signal is 24V DC, current draw 500 mA maximum. The Auxiliary Output terminals are located on the electronic control board (See Schematic on Page 48).

For more details on the use of auxiliary controlled equipment in water treatment systems, consult the EcoWater Systems “Problem Water Guide.”

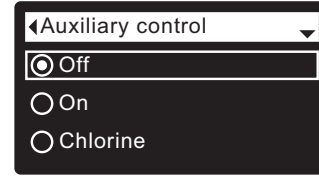
To select an auxiliary control mode:

1. From any of the rolling status screens, press the SELECT (O) button to display the **Main menu**.
2. Press the DOWN (▼) button to scroll through the menu options until **Advanced settings** is highlighted.
3. Press the SELECT (O) button to display the Advanced settings menu.
4. Press the DOWN (▼) button to scroll through the menu options until **Special features** is highlighted.
5. Press the SELECT (O) button to display the Special features menu (See Figure 1419).



**FIG. 141**

6. Press the DOWN (▼) button to scroll through the menu options until **Auxiliary control** is highlighted.
7. Press the SELECT (O) button to display the Auxiliary control menu (See Figure 142).
8. If the desired option already has a dot next to it (See Figure 142), go to Step 9. Otherwise, press the DOWN (▼) or UP (▲) buttons to scroll to the desired option, then press SELECT (O) to choose it.
  - **Off** is the default. The 24V DC output is always off.
  - **On**: The 24V DC output is always on.
  - **Chlorine** can be used to drive a chlorine generator, which produces chlorine, as brine water passes through it, to sanitize the resin during recharges.
  - **Bypass**: Turns 24V DC on during the entire regeneration cycle (when the conditioner’s valve is in bypass and hard water is going to the house).
  - **Chemical feed**: Can be used to run a chemical feed pump. If chosen, the chemical feed volume and timer must be set, as detailed at right)
  - **Water use**: Turns 24V DC on when the conditioner’s turbine indicates water flow. Could drive an air pump for iron or sulfur oxidation.
  - **Fast Rinse**: Turns 24V DC on during the fast rinse portion of the regeneration cycle.
9. Press the SELECT (O) button. The display will go back to the Special features menu (Figure 141).
10. Press the LEFT (◀) button three times to return to the rolling status screens.



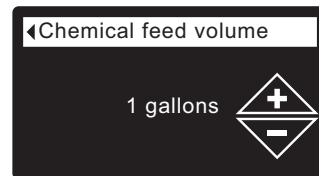
**FIG. 142**

**CHEMICAL FEED**

If the auxiliary control mode has been set to **Chemical feed**, as described in the previous section, two additional lines (**Chemical feed volume** and **Chemical feed timer**) will appear on the Special features menu.

To set these values:

1. From any of the rolling status screens, press the SELECT (O) button to display the **Main menu**.
2. Press the DOWN (▼) button to scroll through the menu options until **Advanced settings** is highlighted.
3. Press the SELECT (O) button to display the Advanced settings menu.
4. Press the DOWN (▼) button to scroll through the menu options until **Special features** is highlighted.
5. Press the SELECT (O) button to display the Special features menu (See Figure 141).
6. Press the DOWN (▼) button to scroll through the menu options until **Chemical feed volume** or **Chemical feed timer** is highlighted.
7. Press the SELECT (O) button to display the Chemical feed volume or Chemical feed timer menu (See Figures 143 & 144).



**FIG. 143**



**FIG. 144**

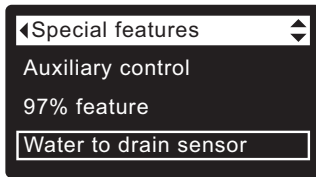
8. Press the UP (▲) or DOWN (▼) buttons to change the value. Hold the button down to rapidly advance.
  - **Chemical feed volume** is the amount of water which will pass through the conditioner/refiner between each activation of the chemical feed equipment.
  - **Chemical feed timer** is how long the output to the chemical feed equipment is energized each time it is activated.
9. Press the SELECT (O) button. The display will go back to the Special features menu (Figure 141).
10. Press the LEFT (◀) button three times to return to the rolling status screens.

**WATER TO DRAIN SENSOR  
(Wi-Fi systems only)**

When this feature is On (the default setting), a sensor in the conditioner/refiner’s valve drain elbow fitting allows the electronic controller to detect whether water is continuously flowing to the drain after a recharge cycle has completed. This could indicate a possible internal valve leak. If detected, an alert will be sent via Wi-Fi, and a display screen will ask whether there is actually water flowing to the drain. Answering No will reset the water-to-drain sensor.

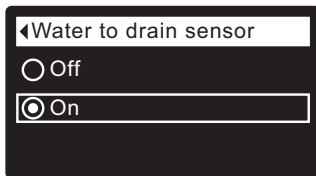
To turn this feature on or off:

1. From any of the rolling status screens, press the SELECT (O) button to display the **Main menu**.
2. Press the DOWN (▼) button to scroll through the menu options until **Advanced settings** is highlighted.
3. Press the SELECT (O) button to display the Advanced settings menu.
4. Press the DOWN (▼) button to scroll through the menu options until **Special features** is highlighted.
5. Press the SELECT (O) button to display the Special features menu (See Figure 145).



**FIG. 145**

6. Press the DOWN (▼) button to scroll through the menu options until **Water to drain sensor** is highlighted.
7. Press the SELECT (O) button to display the Water to drain sensor screen (See Figure 146).

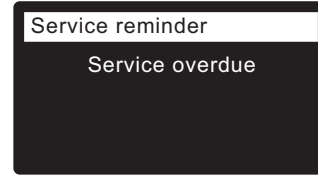


**FIG. 146**

8. If the desired option already has a dot next to it, go to Step 9. Otherwise, press the DOWN (▼) or UP (▲) buttons to scroll to the other option, then press SELECT (O) to choose it.
9. Press the SELECT (O) button. The display will go back to the Special features menu (Figure 145).
10. Press the LEFT (◀) button three times to return to the rolling status screens.

**SERVICE REMINDER (set / reset)**

Use this feature to program the number of months (up to 24) before a “Service overdue” message will appear instead of the rolling status screens (See Figure 147).

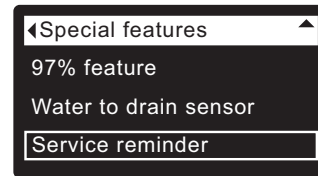


**FIG. 147**

This message also appears on the remote. This will be a reminder to call your dealer for service. Once programmed, this feature displays the number of months and days left until the service reminder.

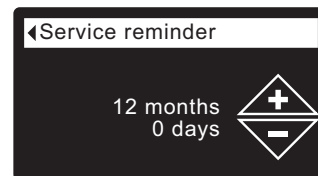
Once the “Service overdue” message has appeared, dealers performing service clear it by setting the number of months until the next service reminder. Set or reset the service reminder as follows:

1. From any of the rolling status screens, press the SELECT (O) button to display the **Main menu**.
2. Press the DOWN (▼) button to scroll through the menu options until **Advanced settings** is highlighted.
3. Press the SELECT (O) button to display the Advanced settings menu.
4. Press the DOWN (▼) button to scroll through the menu options until **Special features** is highlighted.
5. Press the SELECT (O) button to display the Special features menu (See Figure 148).



**FIG. 148**

6. Press the DOWN (▼) button to scroll through the menu options until **Service reminder** is highlighted.
7. Press the SELECT (O) button to display the Service reminder screen (See Figure 149).



**FIG. 149**

8. Press the UP (▲) or DOWN (▼) buttons to set the number of months until the service reminder appears. Repeatedly pressing the DOWN (▼) button until the display reads “Off” turns this feature off and zeros the number of months and days.
9. Press the SELECT (O) button. The display will go back to the Special features menu (Figure 148).
10. Press the LEFT (◀) button three times to return to the rolling status screens.

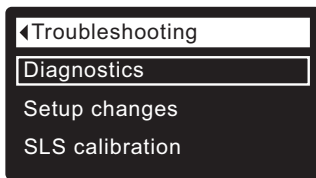


**DIAGNOSTICS**

This feature allows a service technician to check the operating state of individual components in the conditioner/refiner (e.g. valve position) to troubleshoot problems. **If an error code is displayed in place of the rolling status screens, call your dealer for service.**

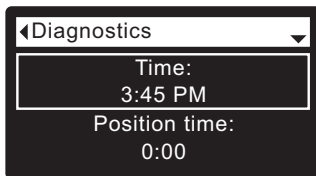
To view the Diagnostics screen:

1. If an error code is displayed, skip Steps 2-7 and go directly to Step 8.
2. To display the Diagnostics screen from any of the rolling status screens (when an error code is not displayed), press the SELECT (O) button to display the **Main menu**.
3. Press the DOWN (▼) button to scroll through the menu options until **Advanced settings** is highlighted.
4. Press the SELECT (O) button to display the Advanced settings menu.
5. Press the DOWN (▼) button to scroll through the menu options until **Troubleshooting** is highlighted.
6. Press the SELECT (O) button to display the Troubleshooting menu (See Figure 150).



**FIG. 150**

7. Make sure **Diagnostics** is highlighted.
8. Press the SELECT (O) button to display the Diagnostics screen (See Figure 151).



**FIG. 151**

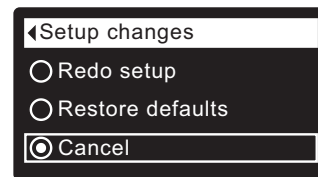
9. Press the DOWN (▼) or UP (▲) buttons to scroll through the list. The following items are displayed:
  - **Time** (current)
  - **Position time** (counts down the time remaining in the current valve position)
  - **Current position** (of the valve: service, fill, brine, backwash, fast rinse or moving)
  - **Requested position** (of the valve)
  - **Motor state** (on or off)
  - **Valve position switch** (open or closed)
  - **Turbine count** (if changing, indicates water flow)
  - **Salt level sensor** (distance reading of sensor)
  - **Drain TDS** (total dissolved solids in ppm)
  - **Drain temperature** (°C)
  - **Tank light switch** (open or closed)
  - **RF module** (detected or not)
  - **Error code** (call for service if a number is displayed)
10. When finished viewing the Diagnostics screen, press the SELECT (O) button. The display will go back to the Troubleshooting menu.

11. Press the LEFT (◀) button three times to return to the rolling status screens (or error code screen if an error condition exists).

**SETUP CHANGES**

This feature allows a service technician to repeat the setup procedure (See Pages 13-15 or 17) or restore the conditioner/refiner's default operating values.

1. From any of the rolling status screens, press the SELECT (O) button to display the **Main menu**.
2. Press the DOWN (▼) button to scroll through the menu options until **Advanced settings** is highlighted.
3. Press the SELECT (O) button to display the Advanced settings menu.
4. Press the DOWN (▼) button to scroll through the menu options until **Troubleshooting** is highlighted.
5. Press the SELECT (O) button to display the Troubleshooting menu (See Figure 150).
6. Press the DOWN (▼) button to scroll through the menu options until **Setup changes** is highlighted.
7. Press the SELECT (O) button to display the Setup changes menu (See Figure 152).



**FIG. 152**

8. If the desired option already has a dot next to it (See Figure 152), go to Step 9. Otherwise, press the DOWN (▼) or UP (▲) buttons to scroll to the desired option, then press SELECT (O) to choose it.
  - **Redo setup** allows you to select a different model code (intended to be used for upgrades or retrofits of existing conditioner/refiners). Model codes are listed on Page 5.
  - **Restore defaults** will reset all customizable settings to their default values and take you through the "wizard" screen setup procedure (See Pages 13-15 or 17).
  - **Cancel** will return to the Troubleshooting menu (Figure 150).
9. Press the SELECT (O) button.

**SLS CALIBRATION**

This feature is used by a service technician replacing a salt level sensor. A replacement salt level sensor is shipped from the factory with numerical values for two calibration points, and these values must be entered into the controller. Instructions for this procedure are supplied with the replacement salt level sensor.

**NOTE:** Do not change the numerical values of the SLS calibration points unless installing a replacement salt level sensor.



## ADDING SALT

If the conditioner/refiner uses all the salt before more is added, hard water will result. Cabinet models have automatic salt level sensing. On two-tank models, lift the brine tank lid and check the salt level frequently. The remote or your Wi-Fi account can also be used to monitor salt. The conditioner/refiner salt status screen has an optional display of the estimated number of days until salt is depleted (“Out of salt in X days”). The conditioner/refiner can also be programmed to display a Low Salt Alarm a certain number of days before salt is estimated to run out (See Page 31).

Be sure that the brinewell cover is on when adding salt.

**TWO-TANK MODELS:** After adding and leveling salt, always set the salt level number on the electronic controller, as described on Page 31.

**NOTE:** In humid areas it is best to keep the salt level less than half full and add salt more often.

**RECOMMENDED SALT:** Cube, pellet, coarse solar, etc., water conditioner salt is recommended. This type of salt is high purity evaporated crystals, sometimes formed and pressed into briquets. It has less than 1% insoluble (not dissolvable in water) impurities. Clean, high grade rock salts are acceptable, but may require frequent brine tank cleaning to remove the “sludge” residue (insolubles) collecting at the bottom of the tank.

**POTASSIUM CHLORIDE:** If you choose potassium chloride (KCl) salt as a regenerant:

- 1) Make sure “Salt type” on the electronic control is set to “KCl”, as shown on Page 31.
- 2) Place only one bag of potassium chloride (KCl) into your conditioner/refiner at a time. The salt storage tank should never contain more than 60 pounds of KCl.

**SALT NOT RECOMMENDED:** Rock salt high in impurities, block, granulated, table, ice melting, or ice cream making salts, etc., are not recommended.

**SALT WITH IRON REMOVING ADDITIVE:** Some salts have an additive to help a water conditioner/refiner handle iron in the water supply. Although this may help keep the resin bed clean, it may also release corrosive fumes that will weaken and shorten the life of some EcoWater Systems conditioner/refiner electronic parts. Iron Out salt is safe to use on two-tank models.

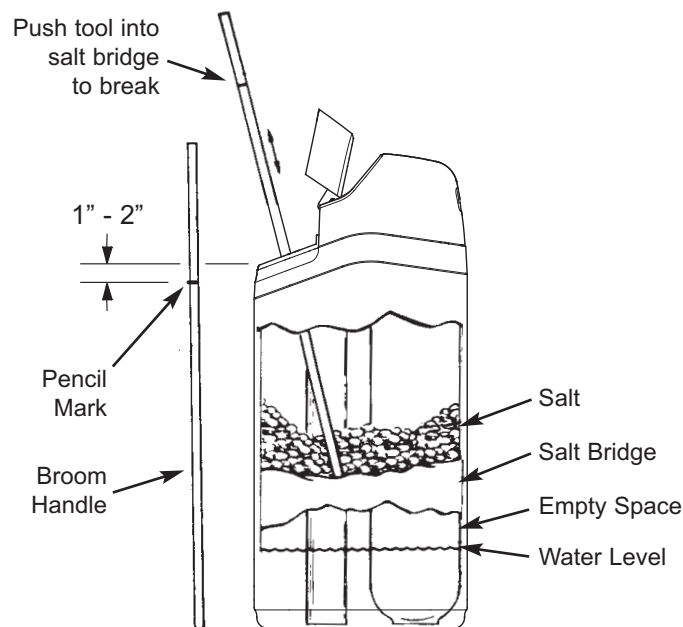
**NOTE:** The Commonwealth of Massachusetts plumbing code 248-CMR shall be adhered to. A licensed plumber shall be used for this installation.

## BREAKING A SALT BRIDGE

Sometimes a hard crust or salt “bridge” forms in the brine tank. This is usually caused by high humidity or the wrong kind of salt. When the salt bridges, an empty space forms between the water and the salt. Then salt will not dissolve in the water to make brine. Without brine, the resin bed is not recharged and hard water will result.

If the storage tank is full of salt, it is difficult to tell whether there is a salt bridge. A bridge may be underneath loose salt. The following is the best way to check for a salt bridge:

Salt should be loose all the way to the bottom of the tank. Hold a broom handle, or like tool, up to the conditioner/refiner, as shown in Figure 153. Make a pencil mark on the handle 1” - 2” below the top of the rim. Then, carefully push it straight down into the salt. If a hard object is felt before the pencil mark is even with the top, it is most likely a salt bridge. Carefully push into the bridge in several places to break it. **Do not try to break the salt bridge by pounding on the outside of the salt tank. You may damage the tank.**



**FIG. 153**

## CLEANING THE NOZZLE & VENTURI

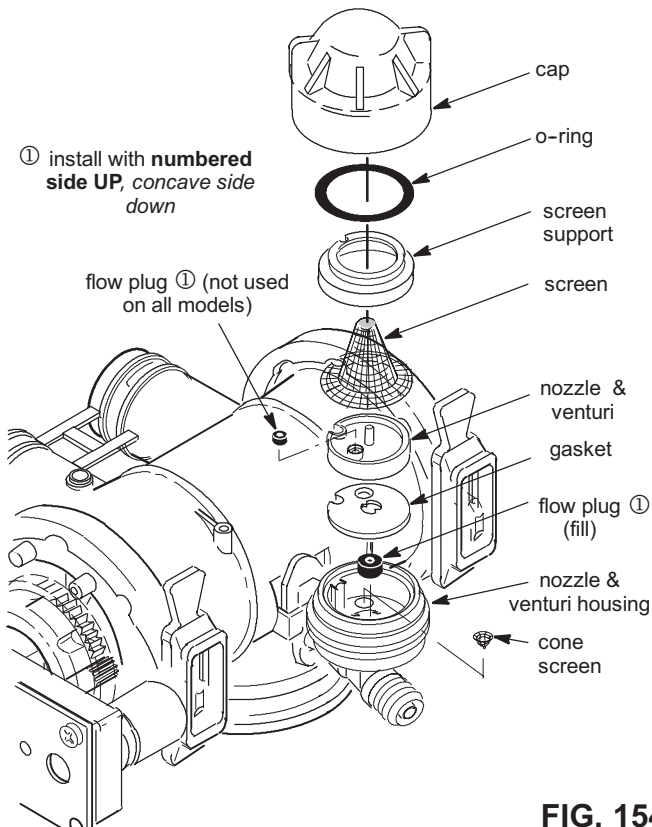
A clean nozzle & venturi (See Figure 154) is necessary for the EcoWater Systems conditioner/refiner to work properly. This small unit creates the suction to move brine from the brine tank into the resin tank. If it should become plugged with dirt, silt, sand, etc., the EcoWater Systems conditioner/refiner will not work and hard water will result.

To get access to the nozzle & venturi, remove the conditioner/refiner's top cover. Put the bypass valve(s) into the bypass position. Be sure the conditioner/refiner is in the service cycle (no water pressure at the nozzle & venturi). Then, holding the nozzle & venturi housing with one hand, turn the cap to remove it. Do not lose the o-ring seal. Lift out the screen support and screen. Then, remove the nozzle & venturi. Wash the parts in warm, soapy water and rinse in fresh water. If needed, use a small brush to remove iron or dirt. Be careful not to scratch, misshape, etc., surfaces of the nozzle & venturi. Also, check and clean the gasket and flow plug(s) if dirty.

Carefully replace all parts in the correct order. Lubricate the o-ring seal with silicone grease and put in place. Install and tighten the cap, by hand only. Do not overtighten, which could break the cap or housing. Put the bypass valve(s) into service (conditioned water) position.

## RESIN BED CLEANING

If the water supply contains clear water iron, regular resin bed cleaning is needed to keep the bed from coating with iron. Use resin bed cleaner, available from EcoWater Systems, following directions on the container. Clean the resin every six months, or more often if iron appears in the conditioned water supply.



**FIG. 154**

**RELIEVING WATER PRESSURE WITH THE BYPASS VALVE(S)**

**CAUTION:** Always relieve water pressure in the EcoWater Systems conditioner/refiner, as described below, before removing parts from the valve or resin tank.

**DE-PRESSURIZE**

1. Put bypass valve(s) into **Bypass** position.
2. Place conditioner/refiner valve in **Fill** position by performing Steps 1 & 7 of Manual Advance Recharge procedure on Page 47.

**PRESSURIZE**

1. Put bypass valve(s) into **Service** position.
2. Return conditioner/refiner valve to **Service** position by performing Steps 10-16 of Manual Advance Recharge procedure on Page 47.

**ALTERNATE METHODS:**

**3-VALVE BYPASS** (See Figure 155)

**DE-PRESSURIZE**

1. Close the INLET valve.
2. Open HOT and COLD conditioned water house faucets.
3. Close the OUTLET valve and open the BYPASS valve.
4. Close all house faucets.

**PRESSURIZE**

1. Open HOT and COLD house faucets.
2. Close the BYPASS valve and open the OUTLET valve.
3. **Slowly**, open the INLET valve.
4. Close all house faucets.

**ECOWATER SYSTEMS BYPASS VALVE**

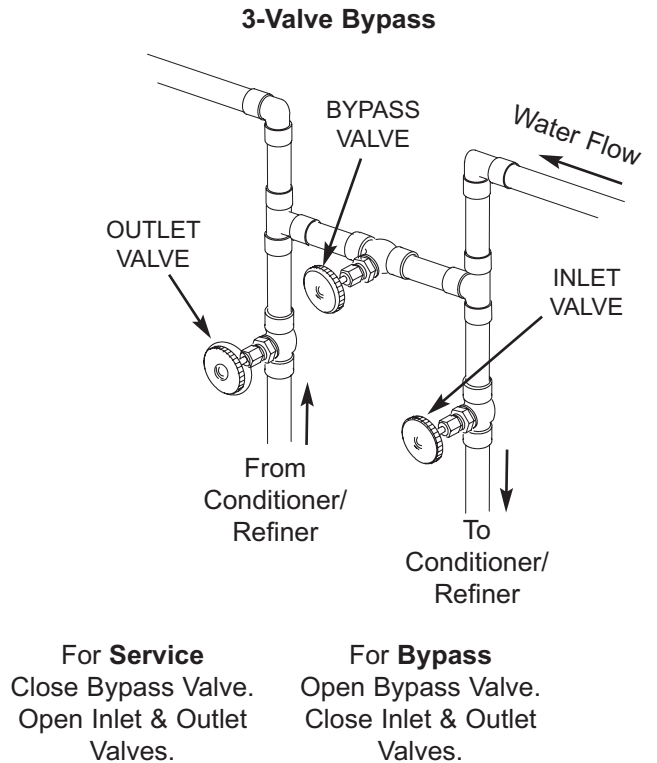
(See Figure 156)

**DE-PRESSURIZE**

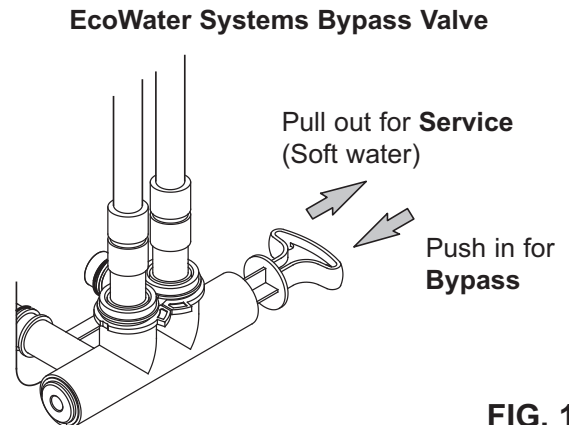
1. Close the house main water supply valve.
2. Open HOT and COLD conditioned water house faucets.
3. Push the bypass valve handle to **Bypass** position.
4. Optional: For hard water bypass to house faucets, reopen the main water supply valve.

**PRESSURIZE**

1. Open main water supply valve if it is closed.
2. Open HOT and COLD house faucets.
3. Pull the bypass valve handle to **Service** position.
4. Close all house faucets.




**FIG. 155**



**FIG. 156**

**TROUBLESHOOTING GUIDE**

<b>PROBLEM</b>	<b>CAUSE</b>	<b>CORRECTION</b>
<b>Remote display shows question marks (?) instead of numbers</b>	Loss of signal between conditioner/refiner and remote.	Make sure conditioner/refiner is powered up. Check signal strength on remote (See Page 22). If signal is weak, move remote to a different location.
<b>Cannot set some conditioner/refiner parameters and display shows a padlock icon:</b> 	Lockout feature is on.	Turn off the lockout feature (See Page 30).
<b>No soft water</b>	No salt in the storage tank.	Add salt (See Page 42) and then initiate a "Recharge now," as shown on Page 32.
	Salt is "bridged."	Break salt bridge (See Page 42) and then initiate a "Recharge now," as shown on Page 32.
	If display is blank, power supply may be unplugged at wall outlet, power cable leads may be disconnected from the electronic control board, fuse may be blown, circuit breaker may be popped, or power supply may be plugged into a switched outlet which is "off."	Check for power loss due to any of these and correct. When power is restored, if the display shows the "Current Time" setting screen (Figure 100 on Page 32), it means time was lost during the outage. Set the current time. Other settings such as hardness are retained in memory during a power loss.
	Bypass valve(s) in bypass position.	Referring to Figure 8 on Page 11, place bypass valve(s) in service position.
	Dirty, plugged or damaged nozzle & venturi.	Take apart, clean and inspect the nozzle & venturi assembly, as shown on Page 43.
	Valve drain hose plugged or restricted.	Drain hose must not have any kinks, sharp bends, or be raised too high above the conditioner/refiner (See Page 11).
<b>Water hard sometimes</b>	Bypassed hard water being used during recharge, due to current time or recharge time settings being incorrect.	Check the current time displayed. If not correct, refer to "Set Current Time" on Page 32. Check the recharge time, as described on Page 33.
	Hardness number setting is too low.	Referring to "Setting Hardness" on Page 33, check the current hardness setting and increase if needed.
	Hot water being used when conditioner/refiner is recharging.	Avoid using hot water during recharges, because water heater refills with hard water.
	Increase in actual hardness of water supply.	Have unconditioned water sample tested. Referring to Page 33, check the current hardness setting and increase if needed.
	Turbine is not turning freely.	Check turbine, as described on Page 46.
<b>Motor stalled or clicking</b>	Motor malfunction or internal valve fault causing high torque on motor.	Contact your dealer for service.
<b>Error code E1, E3 or E4 displayed.</b>	Fault in wiring harness, connections to position switch, switch, valve or motor.	Contact your dealer for service.
<b>Error code E5 displayed.</b>	Electronic control malfunction.	Contact your dealer for service.

**TROUBLESHOOTING - INITIAL CHECKS**

**Always make these initial checks first:**

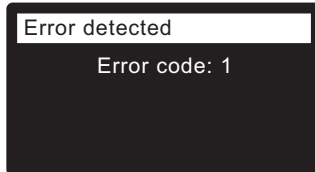
1. Is display blank? Check power source.
2. Is Error code displayed? If so, go to "Automatic Electronic Diagnostics" on the next page.
3. Is correct time displayed? If not, recharges occur at the wrong time. Set current time (See Page 32.)
4. Is there salt in the brine tank? If not, refill.
5. Is salt "bridged" (See Page 42)?
6. Are plumbing bypass valve(s) in service position (See Figure 8 on Page 11)?
7. Are inlet and outlet pipes connected to the EcoWater conditioner/refiner inlet and outlet respectively?

8. Is valve drain hose free of kinks and sharp bends, and not elevated over 8 feet above the floor.
9. Is the brine tube connected (See Fig. 7 on Page 11)?
10. Check the hardness setting (See "Setting Hardness on Page 33). Be sure it is correct for the household's water supply. Perform a hardness test on a raw water sample to compare with the setting.
11. Perform a hardness test on a conditioned water sample to determine whether a problem exists.

If no problem is found after making the initial checks, proceed to "Troubleshooting - Manual Diagnostics" and "Manual Advance Recharge Check" on the next two pages.

## AUTOMATIC ELECTRONIC DIAGNOSTICS

This conditioner/refiner has a self-diagnostic function for the electrical system (except for input power and/or water meter). The controller monitors electronic components and circuits for correct operation. If a malfunction occurs, an **Error code** is displayed (See Figure 157).



**FIG. 157**

The troubleshooting chart on the previous page shows the error codes that could appear, and the possible malfunctions for these codes.

When an error code appears in the display, pressing SELECT (O) will display the **Diagnostics** screen (See Page 41), so a service technician can further isolate the problem.

## REMOVING ERROR CODE

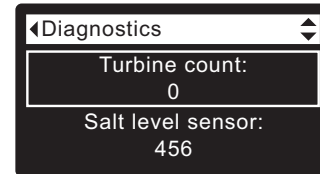
1. Unplug power supply from electrical outlet.
2. Correct problem.
3. Plug power supply back in.
4. Wait for eight minutes while controller operates valve through an entire cycle. The error code will return if the problem was not corrected.

## TROUBLESHOOTING - MANUAL DIAGNOSTICS

1. Display the **Diagnostics** screen, following the procedure on Page 41.
2. Press the DOWN (▼) or UP (▲) buttons to scroll through the list. The following items are displayed:
  - **Time** (current)
  - **Position time** (counts down the time remaining in the current valve position)
  - **Current position** (of the valve: service, fill, brine, backwash, fast rinse or moving) See "Manual Advance Recharge Check" on next page for position verification.
  - **Requested position** (of the valve)
  - **Motor state** (on or off)
  - **Valve position switch** (open or closed)
  - **Turbine count** (indicates water flow) See following section for turbine diagnostics.
  - **Salt level sensor** (distance reading of sensor)
  - **Drain TDS** (total dissolved solids in ppm)
  - **Drain temperature** (°C)
  - **Tank light switch** (open or closed)
  - **RF module** (detected or not)
  - **Error code**

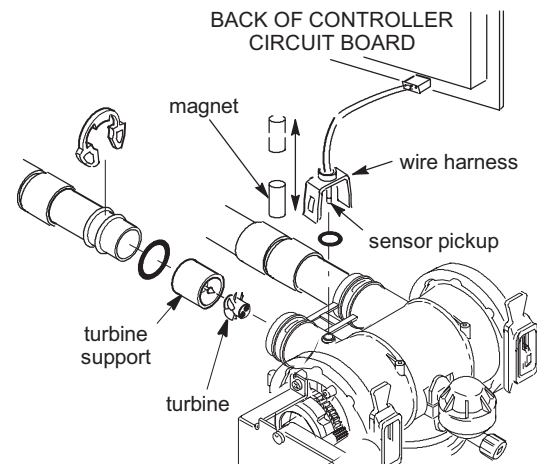
## CHECKING THE TURBINE

1. Display the **Diagnostics** screen, following the procedure on Page 41.
2. Press the DOWN (▼) button to scroll through the list until **Turbine Count** is displayed (See Figure 158).



**FIG. 158**

3. A steady display of "0" (zero) indicates no water flow through the meter (i.e. no conditioned water being used).
4. Open a nearby conditioned water faucet.
5. The number in the display should count upward from 0 and reset at 151 for each gallon of flow.
6. If the display reading does not change with the faucet open, pull the wire harness from the valve outlet port (See Figure 159).



**FIG. 159**

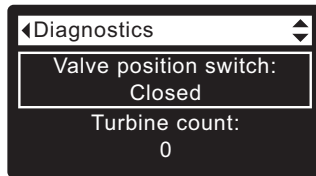
7. Pass a small magnet back and forth in front of the sensor.
- 8a. If the displayed **Turbine Count** does count upward with each pass of the magnet, disconnect the outlet plumbing and check the turbine for binding.
- 8b. If the displayed **Turbine Count** does not count upward with each pass of the magnet, the sensor is probably faulty.



## TROUBLESHOOTING - MANUAL ADVANCE RECHARGE CHECK

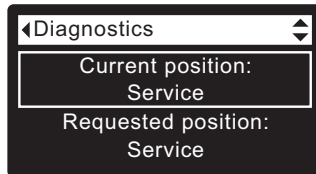
This check verifies proper operation of the position switch, gear motor, brine tank fill, brine draw, recharge flow rates, and other controller functions. Always make the Initial Checks (See Page 45) and the Manual Diagnostics (See Page 46) first.

1. Display the **Diagnostics** screen, following the procedure on Page 41.
2. Press the DOWN (▼) button to scroll through the list until **Valve position switch** is displayed (See Figure 160).



**FIG. 160**

3. Verify that when the switch plunger is down (into one of the detents on the valve motor cam), this screen reads **Open**. When the valve cam is rotating (for example, after Step 7, below), the switch plunger will be up and this screen should read **Closed**.
4. Press the UP (▲) button to scroll through the list until **Current position** is displayed (See Figure 161).



**FIG. 161**

5. Verify that the valve position indicator on the motor cam agrees with the position displayed on the screen
6. Remove the brinewell cover.
7. With the Diagnostics screen displayed, press the RIGHT (▶) button once to advance the valve from **Service** to **Fill**.
8. Shine a flashlight into the brinewell and observe fill water entering the tank.
9. If water does not enter the tank, look for an obstructed nozzle / venturi, fill flow plug or brine tube (See Figure 154 on Page 43).
10. After verifying fill, press the RIGHT (▶) button once to move the valve into **Brine\***. A slow flow of water to the drain will begin. Verify brine draw from the brine tank by shining the flashlight into the brinewell to observe a noticeable drop in the liquid level.

\* If the 2nd Backwash option is set "On" (See Page 37), the valve will enter backwash and fast rinse before brine.

11. If the unit does not draw brine, check for:
  - Dirty or defective nozzle / venturi (See Page 43)
  - Nozzle / venturi not seated on the gasket or gasket not sealing properly
  - Restriction in valve drain, causing back pressure (bends, kinks, elevated too high, etc.)
  - Obstruction in valve or brine tubing
  - Internal valve fault (obstructed outlet disc, wave washer faulty etc.)
12. With the Diagnostics screen displayed, once again press the RIGHT (▶) button to advance the valve to **Backwash**.
13. Look for a fast flow of water from the drain hose. If flow is slow, check for a plugged top distributor, backwash flow plug or drain hose
14. With the Diagnostics screen displayed, once again press the RIGHT (▶) button to advance the valve to **Fast rinse**.
15. Again, look for a fast flow of water from the drain hose. Allow the unit to rinse for several minutes to flush out any brine that may remain from the brine cycle test.
16. With the Diagnostics screen displayed, once again press the RIGHT (▶) button to return the valve to the **Service** position.

**IMPORTANT:** Always return the valve to the **Service** position before exiting this procedure.

## OTHER SERVICE

**Hard Water Bypass** (Hard water "bleeds" into conditioned water supply):

1. Faulty inlet disc, seal or wave washer (See Pages 54 and 55).
2. Missing or faulty o-ring(s) at valve connection to riser pipe.

**Water Leaks from Drain Hose** during service:

1. Faulty inlet disc, seal or wave washer.
2. Faulty o-ring on inlet disc shaft.
3. Faulty outlet disc, seal or wave washer.

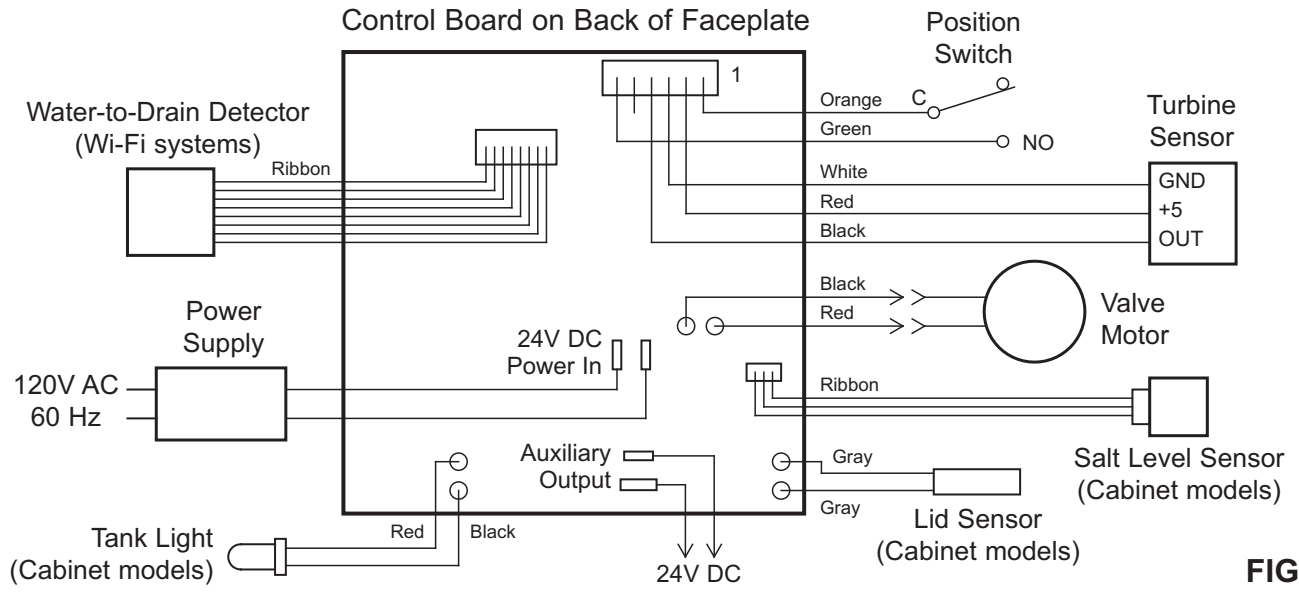
**Flooded Salt Tank:**

1. Nozzle / venturi plugged.
2. Faulty valve seals.
3. Restricted or plugged backwash / fast rinse controls.
4. Restricted or plugged drain line.

**Water Has Salty Taste:**

1. House water pressure low. Adjust well pump.
2. Partially restricted valve drain hose, top distributor, backwash flow plug, resin tank internal riser pipe, or bottom distributor.
3. Backwash and fast rinse times have been reduced from default settings.
4. Wrong model code.

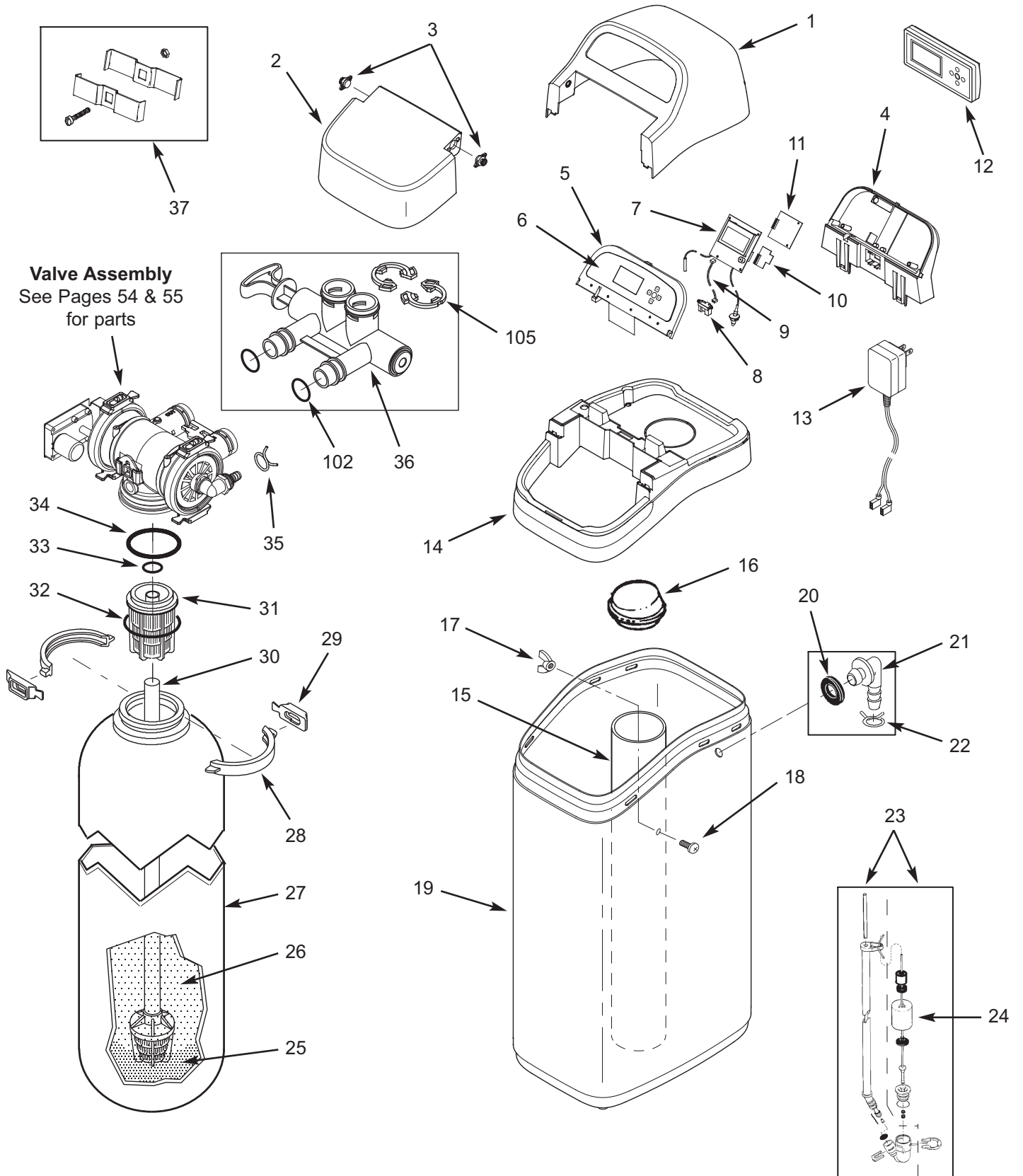
**WIRING SCHEMATIC**



**FIG. 162**



**ECOWATER SYSTEMS CONDITIONER/REFINER ASSEMBLY**  
(Cabinet Models)



## ECOWATER SYSTEMS CONDITIONER ASSEMBLY (Cabinet Models)

Key No.	Part No.	Description
1	7353323	Cover, Top
2	7353315	Salt Lid
3	7354971	Damper/Hinge (2 req.)
4	7353349	Support, Faceplate
–	7357856	Repl. Faceplate Assembly (includes Key Nos. 5-9)
5	↑	Faceplate
6	↑	Keypad/Decal
7	↑	Electronic Controller (PWA), with Tank Light Assembly & Lid Sensor
–	7357880	Repl. Salt Level Sensor Assembly (includes Key Nos. 8 & 9)
8	↑	Salt Level Sensor, Long Range (also incl. in Repl. Faceplate Asm.)
9	↑	Cable, Salt Level Sensor (also incl. in Repl. Faceplate Asm.)
10	7341520	Repl. Wi-Fi Board (for Wi-Fi systems only)
11	7343491	Repl. Remote Transceiver Board (for non-Wi-Fi systems only)
12	7292967	Repl. Remote, incl. batteries (for non-Wi-Fi systems only)
13	7351054	Power Supply, 24V DC
14	7353307	Rim, ECR3700R20 & ECR3700R30
	7357521	Rim, ERR3700R20
15	7214375	Brinewell
16	7155115	Cover, Brinewell
–	7357822	Brinewell Mounting Hardware Kit, (includes Key Nos. 17 & 18)
17	↑	Nut
18	↑	Screw

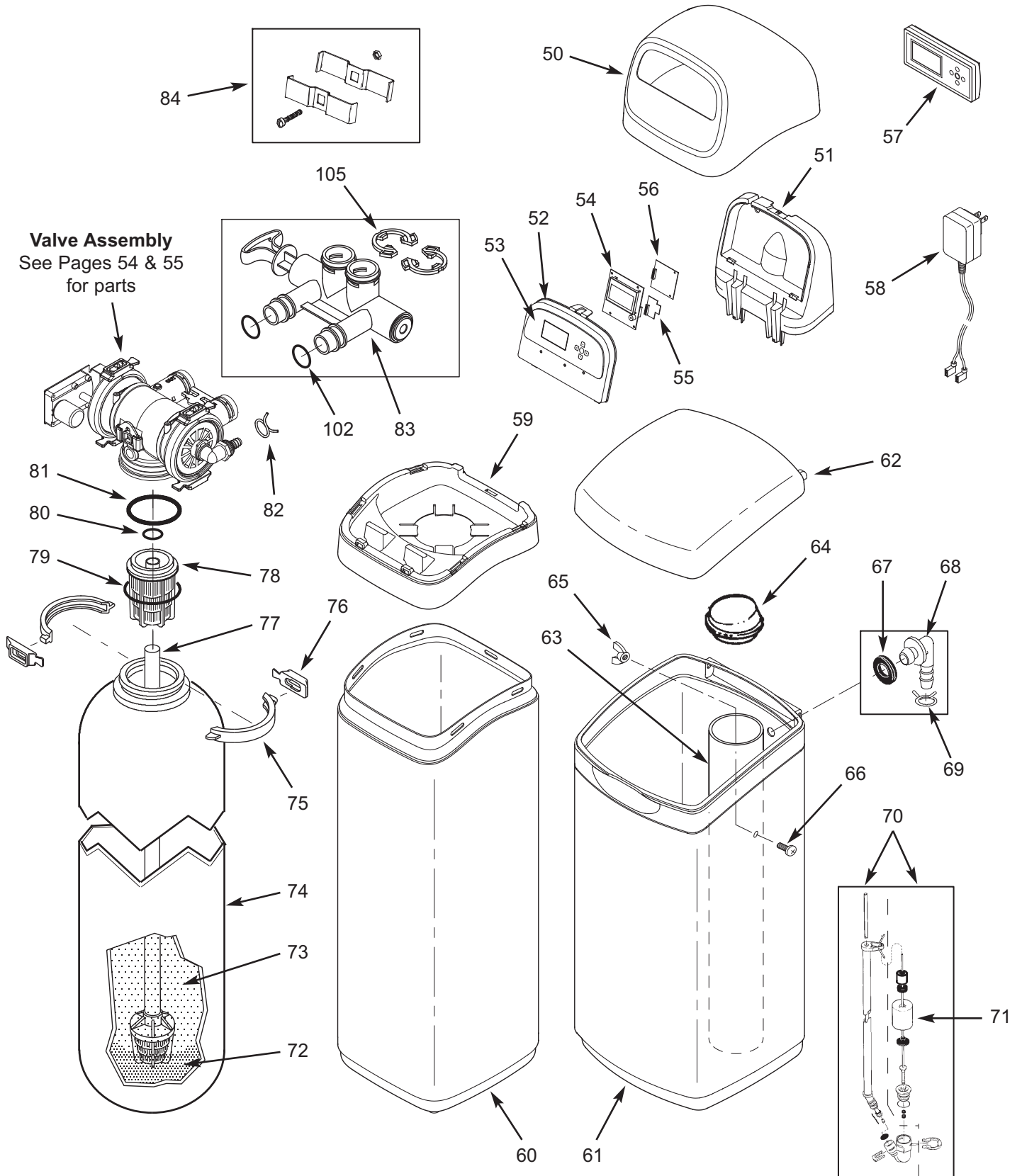
Key No.	Part No.	Description
19	7353187	Repl. Brine Tank
–	7331258	Overflow Hose Adaptor Kit (includes Key Nos. 20-22)
20	↑	Grommet
21	↑	Adaptor Elbow
22	↑	Hose Clamp ★
23	7310210	Brine Valve Assembly
24	7327568	Float, Stem & Guide Assembly
25	7124415	Gravel, 17 lbs.
26	0502272	Resin, 1 cu. ft. (standard mesh)
	7052202	Resin, 1 cu. ft. (fine mesh)
	7175149	Activated Carbon (ERR3700R20)
27	7304235	Resin Tank, 8" dia. x 35" (ECR3700R20)
	7113066	Resin Tank, 10" dia. x 35" (ECR3700R30 & ERR3700R20)
–	7331177	Tank Neck Clamp Kit (includes 2 ea. of Key Nos. 28 & 29)
28	↑	Clamp Section (2 req.)
29	↑	Retainer Clip (2 req.)
30	7105047	Repl. Bottom Distributor
31	7077870	Top Distributor
–	7112963	Distributor O-Ring Kit (includes Key Nos. 32-34)
32	↑	O-Ring, 2-3/4" x 3"
33	↑	O-Ring, 13/16" x 1-1/16"
34	↑	O-Ring, 2-7/8" x 3-1/4"
35	7112882	Hose Clamp ★
36	7214383	Bypass Valve, 1" ★ (includes 2 ea. of Key Nos. 102 & 105)
37	7248706	Ground Clamp Kit ★

★ Not included with conditioner/refiner

To order parts, call your local EcoWater dealer or go to [www.ecowater.com](http://www.ecowater.com) to locate a dealer in your area.



**ECOWATER SYSTEMS CONDITIONER/REFINER ASSEMBLY**  
(Two-Tank Models)



## ECOWATER SYSTEMS CONDITIONER ASSEMBLY (Two-Tank Models)

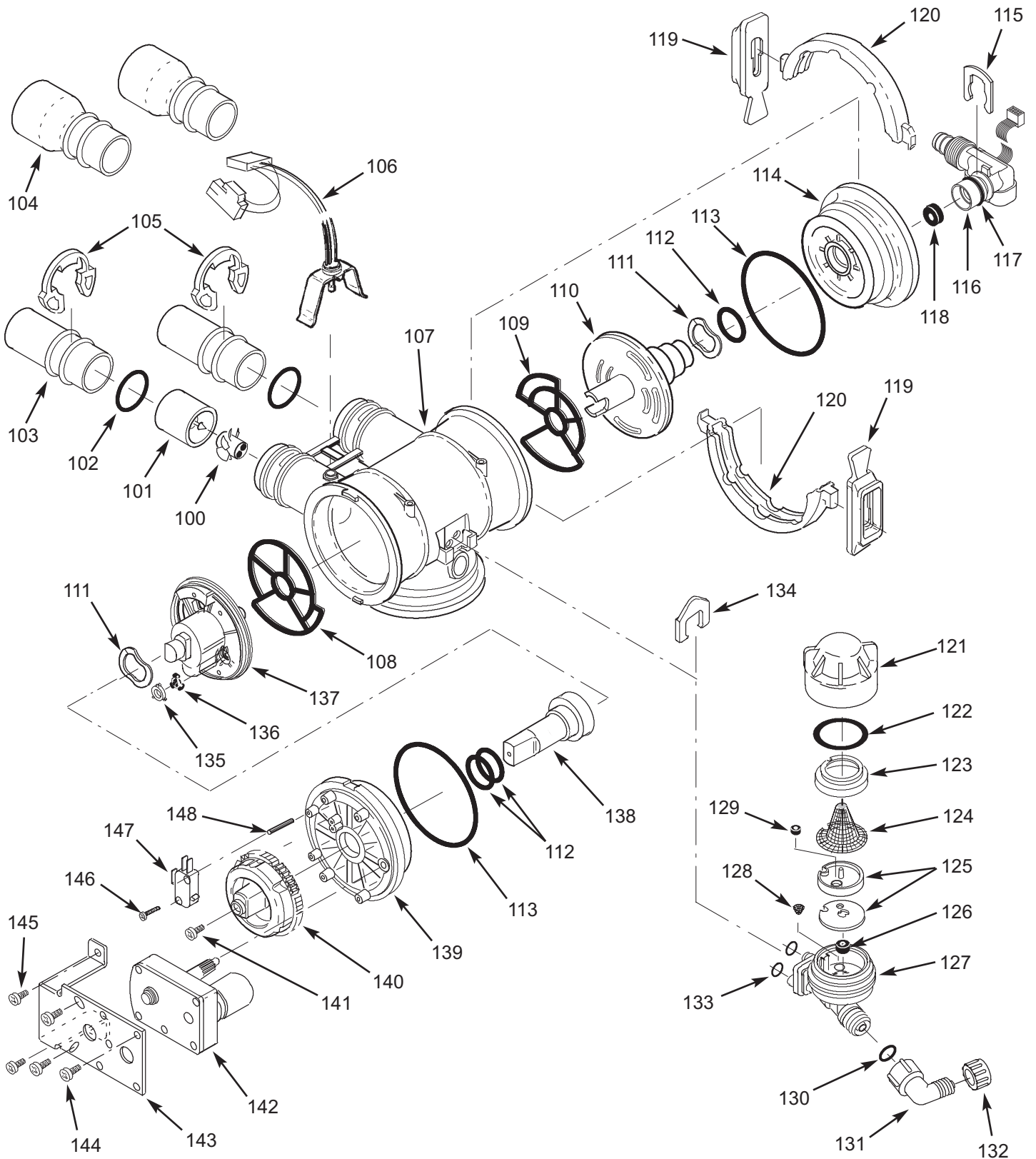
Key No.	Part No.	Description
50	7353365	Cover, Top
51	7353381	Support, Faceplate
–	7357864	Repl. Faceplate Assembly (includes Key Nos. 52-54)
52	↑	Faceplate
53	↑	Keypad/Decal
54	↑	Electronic Controller (PWA)
55	7341520	Repl. Wi-Fi Board (for Wi-Fi systems only)
56	7343491	Repl. Remote Transceiver Board (for non-Wi-Fi systems only)
57	7292967	Repl. Remote, incl. batteries (for non-Wi-Fi systems only)
58	7351054	Power Supply, 24V DC
59	7353357	Rim, ECR3702R30, ECR3702R40, ECR3702R50S & ECR3702R70
	7357539	Rim, ERR3702R30, ERR3702R50 & ERRC3702R50
60	7353226	Shroud, 35" (ECR3702R30)
	7353234	Shroud, 47" (ERR3702R30 & ECR3702R40)
	7353242	Shroud, 54" (R50 & R70 models)
61	7355032	Brine Tank
62	7355016	Cover, Brine Tank
63	7214375	Brinewell
64	7155115	Cover, Brinewell
–	7357822	Brinewell Mounting Hardware Kit, (includes Key Nos. 65 & 66)
65	↑	Nut
66	↑	Screw
–	7331258	Overflow Hose Adaptor Kit (includes Key Nos. 67-69)
67	↑	Grommet
68	↑	Adaptor Elbow
69	↑	Hose Clamp *

Key No.	Part No.	Description
70	7310197	Brine Valve Assembly (ECR3702R30, ERR3702R30 & ECR3702R40)
	7310210	Brine Valve Assembly (R50 & R70 models)
71	7113008	Float, Stem & Guide Assembly (ECR3702R30, ERR3702R30 & ECR3702R40)
	7327568	Float, Stem & Guide Assembly (R50 & R70 models)
72	7124415	Gravel, 17 lbs.
73	0502272	Resin, 1 cu. ft. (standard mesh)
	7052202	Resin, 1 cu. ft. (fine mesh)
	7175149	Activated Carbon (ERR3702R30 & ERR3702R50)
	7339141	Catalytic Carbon, 1 cu. ft. (ERRC3702R50)
74	7113066	Resin Tank, 10" dia. x 35" (ECR3702R30)
	7092202	Resin Tank, 10" dia. x 47" (ERR3702R30 & ECR3702R40)
	7113074	Resin Tank, 12" dia. x 54" (R50 & R70 models)
–	7331177	Tank Neck Clamp Kit (includes 2 ea. of Key Nos. 75 & 76)
75	↑	Clamp Section (2 req.)
76	↑	Retainer Clip (2 req.)
77	7105047	Repl. Bottom Distributor
78	7077870	Top Distributor
–	7112963	Distributor O-Ring Kit (includes Key Nos. 79-81)
79	↑	O-Ring, 2-3/4" x 3"
80	↑	O-Ring, 13/16" x 1-1/16"
81	↑	O-Ring, 2-7/8" x 3-1/4"
82	7112882	Hose Clamp *
83	7214383	Bypass Valve, 1" * (includes 2 ea. of Key Nos. 102 & 105)
84	7248706	Ground Clamp Kit *

\* Not included with conditioner/refiner

To order parts, call your local EcoWater dealer or go to [www.ecowater.com](http://www.ecowater.com) to locate a dealer in your area.

**VALVE ASSEMBLY (All Models)**



**VALVE ASSEMBLY (All Models)**

Key No.	Part No.	Description
-	7290931	Turbine & Support Assembly, including 2 O-Rings (See Key No. 102) & 1 ea. of Key Nos. 100 & 101, ECR3700R20, ERR3700R20, ECR3700R30 & ECR3702R30
	7331703	Turbine & Support Assembly (includes 1 ea. of Key Nos. 100, 101 & 2 ea. of Key No. 102), ERR-3702R30, R40, R50 & R70 models
100	↑	Turbine
101	↑	Turbine Support & Shaft
102	7311127	O-Ring, 1-1/16" x 1-5/16", single (2 req.)
	7336410	O-Ring, 1-1/16" x 1-5/16", pack of 20
103	7077642	Copper Tube, 1", single (2 req.)
	7344138	Copper Tube, 1", pack of 10 (includes 10 ea. of Key No. 52)
104	7234553	Copper Tube, 1-1/4" pipe (2 req.)
105	7089306	Clip, 1", single (2 req.)
	7336428	Clip, 1", pack of 20
106	7309811	Wire Harness w/pos. switch conn.
107	7159949	Disc Valve Housing
108	7334133	Outlet End Seal, single ❶
	7353404	Outlet End Seal, pack of 20
109	7334125	Inlet End Seal, single ❶
	7353399	Inlet End Seal, pack of 20
-	7135270	Inlet & Outlet End Seal Kit (includes 1 ea. of Key Nos. 58 & 59)
110	7214286	Inlet Disc ❶
111	7058216	Wave Washer (2 req.)
112	7170220	O-Ring, 3/4" x 15/16", single (3 req.) ❶
	7336444	O-Ring, 3/4" x 15/16", pack of 30
113	7170296	O-Ring, 2-7/8" x 3-1/4", single (2 req.)
	7336452	O-Ring, 2-7/8" x 3-1/4", pack of 20
114	7077498	Inlet End Cap
115	7142942	Clip, Drain
116	7357830	Drain Elbow Assembly w/Water-to-Drain Sensor, for Wi-Fi systems (includes Key No. 117)
	7219066	Drain Elbow, for non-Wi-Fi systems
117	7170327	O-Ring, 5/8" x 13/16"
118	1110600	Flow Plug, Fast Rinse, 2.4 gpm, ECR3700R20
	7097969	Flow Plug, Fast Rinse, 3.0 gpm, ERR3700R20, R30 & R40 models
	7097977	Flow Plug, Fast Rinse, 4.0 gpm, R50 & R70 models
-	7331177	Tank Neck Clamp Kit (includes 2 ea. of Key Nos. 119 & 120)
119	↑	Retainer Clip (4 req.) ❷
120	↑	Clamp Section (4 req.) ❷

Key No.	Part No.	Description
-	7137507	Nozzle & Venturi Assembly (includes Key Nos. 71-79), ECR3700R20 ❸
	7091866	Nozzle & Venturi Assembly (includes Key Nos. 71-78), ERR3700R20, R30 & R40 models
	7085247	Nozzle & Venturi Assembly (includes Key Nos. 71-78), R50 & R70 models
121	7199729	Cap
122	7170262	O-Ring, 1-1/8" x 1-3/8", single
	7336436	O-Ring, 1-1/8" x 1-3/8", pack of 20
123	7167659	Screen Support
124	7146043	Screen
125	7187772	Nozzle & Venturi (red) Kit w/Gasket, R20 ❸, R30 & R40 models
	7114533	Nozzle Venturi (blue) Kit w/Gasket, R50 & R70 models
	7204362	Gasket only, single
	7336486	Gasket only, pack of 20
126	1148800	Flow Plug, Fill, 0.3 gpm
127	7081104	Housing, Nozzle & Venturi
128	7095030	Cone Screen
129	7084607	Flow Plug, 0.15 gpm, ECR3700R20 ❸
130	7292323	O-Ring, 3/16" x 7/16"
131	7120526	Elbow, 90°
132	1202600	Nut - Ferrule
133	7170319	O-Ring, 1/4" x 3/8" (2 req.)
134	7081201	Clip, Nozzle & Venturi
135	7078313	Retainer
136	7104774	Flow Washer, Backwash, 1.0 gpm, ECR 3500R20
	7104570	Flow Washer, Backwash, 1.7 gpm, ERR3700R20, R30 & R40 models - not used on R50 & R70 models
137	7214278	Outlet Disc ❶
138	7091329	Driver, Outlet Disc
139	7159965	Outlet End Cap
140	7283497	Cam & Gear
141	7203104	Washerhead Screw, #8-18 x 1/2"
142	7281275	Motor, incl. Key No.143
143	7289702	Bracket, Motor
144	7168524	Screw, #10-32 x 5/16" (3 req.)
145	7103972	Screw, #8-18 x 7/16" (2 req.)
146	7140738	Screw, #4-24 x 3/4"
147	7145186	Switch
148	7140746	Expansion Pin

❶ Included in Disc Kit, #7218688

❷ Not all parts are shown

❸ Use red nozzle along with Key No. 129 on water pressures of 50 psi or less



**FOR IOWA USE ONLY**

All sales in Iowa require the following signature before consummation of sale. These signatures must be retained by seller/renter for 2 years minimum.

Buyer/Renter \_\_\_\_\_ Date \_\_\_\_\_

Seller \_\_\_\_\_ Date \_\_\_\_\_

Seller's Address \_\_\_\_\_

Seller's Phone No. \_\_\_\_\_